

CFORCE 450

 CFMOTO

CF400AU/ CF400AU-L OWNER'S MANUAL

READ THIS MANUAL CAREFULLY
It contains important safety information

This ATV should not be ridden by anyone under 16
years of age. Passenger under 12 are prohibited.



⚠️ WARNING

Improper vehicle use can result in SEVERE INJURY or DEATH

NEVER Operate:

- Without first viewing owner' s manual and quick start guide.
- With more than one passenger.
- On public roads.
- On paved surfaces-pavement may seriously affect handling and control.
- With Non-CFMOTO approved accessories.

ALWAYS:

- Keep hands and feet inside vehicle.
- Reduce speed and use extra caution when carrying a passenger.
- Operate slowly in reverse-avoid sharp turns or sudden braking.
- Make sure passenger reads and understands all safety labels.
- Watch for branches or other hazards that could enter vehicle.



**ALWAYS USE AN APPROVED
HELMET AND PROTECTIVE
GEAR**



**NEVER USE DRUGS
OR ALCOHOL**

Locate and Read Owner's manual, Follow all INSTRUCTIONS and WARNINGS. If Owner's manual is missing, contact a CFMOTO dealer for replacement.

 WARNING

Read, understand, and follow all of the instructions and safety precautions in this manual and on all product labels. Failure to follow the safety precautions could result in serious injury or death.

 WARNING

The engine exhaust gas from this product contains CO, which is deadly gas and could cause headache, giddy, disgusting or lose consciousness, even death.

INSTRUCTIONS

Thank you for purchasing a CFMOTO vehicle, and welcome to join our worldwide family of CFMOTO owners.

We proudly produce an exciting line of utility and recreational products.

- All terrain vehicle (ATV)
- Utility vehicle (patrol, forest protecting and hunting)
- Motorcycles and scooters

CFMOTO, a company which is specialized in production of liquid-cooled engine, is the top-level supplier in China. Compared to same displacement of air-cooled engine, engine cooling effect is better, oil temperature can be adjusted more freely, more powerful and lower fuel consumption, longer engine working life.

For safe and enjoyable operation of your vehicle, be sure to follow the instructions and recommendations in this owner's manual. Your manual contains instructions for minor maintenance, but information about major repairs is outlined in the CFMOTO service manual and should be performed only by CFMOTO service dealer and technician.

Your CFMOTO dealer knows your vehicle best and is interested in your total satisfaction. Be sure to return to your dealership for all of your service.

Due to constant improvements in the design and quality of production components, some minor discrepancies may result between the actual vehicle and the information presented in this publication. Depictions and/or procedures in this publication are intended for reference use only.

TABLE OF CONTENTS

VIN No	5
Operator Safety	6
Safety decals and locations	37
Features and Controls	43
Operation	63
Maintenance & Lubrication	89
Clean & Storage	131
Troubleshooting	137
Specifications	151
Wiring diagram	156

VEHICLE IDENTIFICATION NUMBER

Record your ATV's identification numbers in the spaces provided, Remove the spare key and store in a safe place. Your key can be duplicated only by mating key blank with one of your existing keys. So if both keys are lost, the complete lock kits have to be replaced.



CF400AU Vehicle identification number: _____

CF400AU-L Vehicle identification number: _____

Vehicle model number: _____

Engine serial number: _____

Operator Safety

⚠️ WARNING

Failure to heed the warnings contained in this manual can result in serious injury or death. An ATV is not a toy and can be hazardous to operate. This vehicle handles differently from other vehicles, such as motorcycles and cars. A collision or rollover can occur quickly, even during routine maneuvers, like turning, or over obstacles, if you fail to take proper precautions.

Read this owner's manual. Understand all safety warnings, precautions and operating procedures before operating an ATV.

Age Restrictions

This vehicle is an ADULT VEHICLE ONLY. Operation is prohibited for anyone under the age of 16.

Know Your Vehicle

As the operator of the vehicle, you are responsible for your personal safety, the safety of others, and the protection of our environment. Read and understand your owner's manual, which includes valuable information about all aspects of your vehicle, including safe operating procedures.

Operator Safety Safety Training

When you purchased your new ATV, your dealer offered a hands-on safety training course that covers all aspects of vehicle safety. You were also provided with printed materials that explain safe operating procedures. You should review this information on a regular basis. If you purchased a used ATV from a party other than a dealer, you can request this free safety training from any authorized dealer. Familiarize yourself with all laws and regulations concerning the operation of this vehicle in your area. We strongly advise you to strictly follow the recommended maintenance program outlined in your owner's manual. This preventive maintenance program is designed to ensure that all critical components on your vehicle are thoroughly inspected at specific intervals. The following signal words and symbols appear throughout this manual and on your ATV. Your safety is involved when these words and symbols are used. Become familiar with their meanings before reading the manual.

WARNING

The safety alert symbol indicates a potential personal injury hazard.

Operator Safety

WARNING

The safety alert warning indicates a potential hazard that may result in serious injury or death.

CAUTION

The safety alert caution indicates a potential hazard that may result in minor personal injury or damage to the vehicle.

CAUTION

A caution indicates a situation that may result in damage to the vehicle.

NOTE

A note will alert you to important information or instructions.

WARNING

Serious injury or death can result if you don't follow these instructions and procedures, which are outlined in further detail within your owner's manual.

- Read this manual and all labels carefully, and follow the operating procedures described.

Operator Safety

- Never operate an ATV without proper instruction. Take a training course. Beginners should receive training from a certified instructor. Contact an authorized ATV dealer to find out about the training courses nearest you.
- Never allow anyone under 16 years of age to operate this ATV.
- Never permit a guest to operate the ATV unless the guest has read this manual and all product labels and has completed a certified safety training course.
- Never operate an ATV without wearing an approved helmet that fits properly. Always wear eye protection (goggles or face shield), gloves, boots, a long-sleeved shirt or jacket, and long pants.
- Never consume alcohol or drugs before or while operating an ATV.
- Never operate at excessive speeds. Travel at speeds appropriate for the terrain, visibility and operating conditions, and your experience.
- Never attempt wheelies, jumps or other stunts.
- Always inspect your ATV before each use to make sure it's in safe operating condition. Always follow the inspection and maintenance procedures and schedules outlined in your owner's manual.

Operator Safety

- Always keep both hands on the handlebars and both feet on the foot-rests of the ATV during operation.
- Always travel slowly and use extra caution when operating on unfamiliar terrain. Be alert to changing terrain conditions.
- Never operate on excessively rough, slippery, or loose terrain.
- Always follow proper turning procedures as described in this manual. Practice turning at low speeds before attempting to turn at faster speeds. Do not turn at excessive speeds.
- Always have the ATV inspected by an authorized dealer if it's been involved in an accident.
- Never operate on hills too steep for the ATV or for your abilities. Practice on smaller hills before attempting larger hills.
- Always follow proper procedures for climbing hills. Check the terrain carefully before ascending a hill. Never climb hills with excessively slippery or loose surfaces. Shift your weight forward. Never open the throttle suddenly or make sudden gear changes. Never go over the top of a hill at high speed.

Operator Safety

- Always follow proper procedures for going downhill and for braking on hills. Check the terrain carefully before you start down a hill. Shift your weight backward. Never go down a hill at high speed. Avoid going down a hill at an angle, which would cause the vehicle to lean sharply to one side. Travel straight down the hill when possible.
- Always follow proper procedures for crossing the side of a hill. Avoid hills with excessively slippery or loose surfaces. Shift your weight to the uphill side of the ATV. Never attempt to turn the ATV around on any hill until you've mastered (on level ground) the turning technique outlined in this manual. Avoid crossing the side of a steep hill when possible.
- Always use proper procedures if you stall or roll backwards while climbing a hill. To avoid stalling, maintain a steady speed when climbing a hill. If you stall or roll backwards, follow the special procedure for braking described in this manual. Always dismount on the uphill side, or to either side if the ATV is pointed straight uphill. Turn the ATV around and remount following the procedure described in this manual.

Operator Safety

- Always check for obstacles before operating in a new area. Never attempt to operate over large obstacles, such as rocks or fallen trees. Always follow proper procedures when operating over obstacles as described in this manual.
- Always be careful of skidding or sliding. On slippery surfaces like ice, travel slowly and use extra caution to reduce the chance of skidding or sliding out of control.
- Avoid operating the ATV through deep or fast-flowing water. If it ' s unavoidable, travel slowly , balance your weight carefully, avoid sudden movements, and maintain a slow and steady forward motion. Do not make sudden turns or stops, and do not make sudden throttle changes.
- Wet brakes may have reduced stopping ability. Test your brakes after leaving water. If necessary, apply them lightly several times to allow friction to dry out the pads.
- Always check for obstacles or people behind the ATV before operating in reverse. When it s safe to proceed in reverse, move slowly and avoid turning at sharp angles.

Operator Safety

- Always use the size and type of tires specified for your ATV, and always maintain proper tire pressure.
- Never modify an ATV through improper installation or use of accessories.
- Never exceed the stated load capacity for your ATV. Cargo must be properly distributed and securely attached. Reduce speed and follow the instructions in this manual for carrying cargo or towing. Allow a greater distance for braking.
- Always remove the ignition key when the vehicle is not in use to prevent unauthorized use or accidental starting.
- Child or pets shall not be carried on the racks.
- Never touch running parts, such as wheels, drive shaft, etc.

FOR MORE INFORMATION ABOUT ATV SAFETY, PLEASE CONTACT WITH YOUR DEALER.

Operator Safety Equipment Modifications

We are concerned with the safety of our customers and for the general public. Therefore, we strongly recommend that consumers do not install on an ATV any equipment that may increase the speed or power of the vehicle, or make any other modifications to the vehicle for these purposes. Any modifications to the original equipment of the vehicle create a substantial safety hazard and increase the risk of body injury. The warranty on your ATV is terminated if any equipment has been added to the vehicle, or if any modifications have been made to the vehicle, that increase its speed or power.

NOTE

The addition of certain accessories, including (but not limited to) mowers, blades, tires, sprayers, or large racks, may change the handling characteristics of the vehicle. Use only approved accessories, and familiarize yourself with their function and effect on the vehicle.

Operator Safety

WARNING

POTENTIAL HAZARD

Operating this ATV without proper instruction.

WHAT CAN HAPPEN

The risk of an accident is greatly increased if the operator does not know how to operate the ATV properly in different situations and on different types of terrain.

HOW TO AVOID THE HAZARD

Beginning and inexperienced operator should complete the certified training course offered by dealer. Operators should regularly practice the skills learned in the course and the operating techniques described in the owner's manual.

WARNING

POTENTIAL HAZARD

Failure to follow the age recommendations for this ATV.

Operator Safety

WHAT CAN HAPPEN

Severe injury and/or death could occur if a child under the minimum age recommendation operates an ATV.

Even though a child may be within the recommended age group for operating some ATVs, he/she may not have the skills, abilities or judgment needed to operate an ATV safely and could be susceptible to accident or injury.

HOW TO AVOID THE POTENTIAL

Operation is prohibited for anyone under 16 years of age.

WARNING

POTENTIAL HAZARD

Carrying passengers more than the rated passenger capacity.

WHAT CAN HAPPEN

This is a 2-person ATV. Only 1 passenger is allowed. Carrying 2 or more passengers greatly reduces the operator's ability to balance and control the ATV, which could cause an accident and injury to the operator and/or passengers.

Operator Safety

HOW TO AVOID THE HAZARD

Never carry 2 or more passengers on this ATV.

⚠ WARNING

POTENTIAL HAZARD

Carrying a passenger in the rear rack.

WHAT CAN HAPPEN

A passenger riding in the rear rack could be ejected from the vehicle unexpectedly or may contact moving components, both of which can result in severe injury or death.

HOW TO AVOID THE HAZARD

Never allow passengers to ride in the rear rack.

POTENTIAL HAZARD

Operating this ATV without wearing an approved helmet, eye protection.

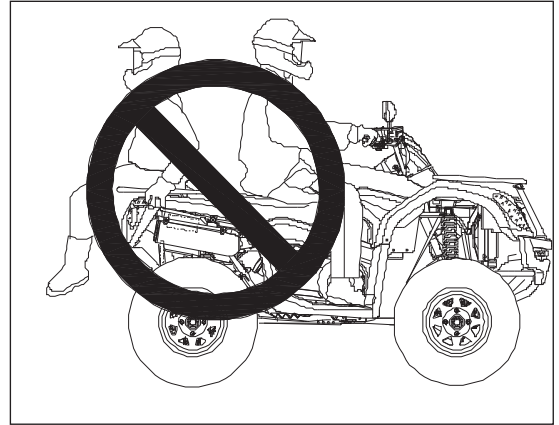

Operator Safety

And protective clothing.

WHAT CAN HAPPEN

Operating an ATV without an approved helmet increases the risk of a severe head injury or death in the event of an accident. Operating without eye protection could result in an accident and could increase the chance of a severe eye injury in the event of an accident.

HOW TO AVOID THE HAZARD

Always wear an approved helmet that fits properly. Always wear eye protection (goggles or face shield), gloves, long-sleeved shirt or jacket, and long pants.

⚠️ WARNING

POTENTIAL HAZARD

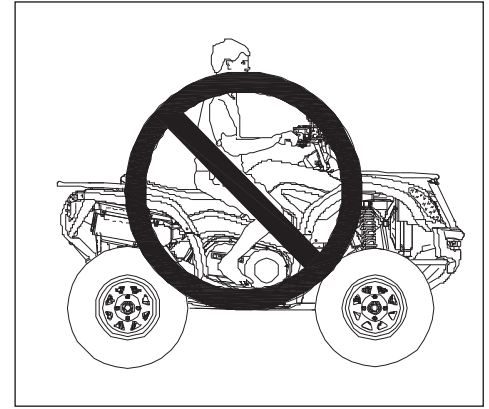

Operator Safety

Operating the ATV after consuming alcohol or drugs.

WHAT CAN HAPPEN

Consumption of alcohol and/or drugs could seriously affect operator judgment. Reaction time may be slower and operator balance and perception could be affected. Consumption of alcohol and/or drugs before or while operating an ATV could result in an accident causing severe injury or death.

HOW TO AVOID THE HAZARD

Never consume alcohol or drugs before or while operating an ATV.

⚠ WARNING

POTENTIAL HAZARD

Operating the ATV at excessive speeds.

WHAT CAN HAPPEN

Excessive speed increase the operator's chance of losing control of the ATV, which can result in an accident.



Operator Safety

HOW TO AVOID THE HAZARD

Always operate the ATV at a speed that's proper for the terrain, visibility and operating conditions, and your experience.

⚠ WARNING

POTENTIAL HAZARD

Attempting wheelies, jumps and other stunts.

WHAT CAN HAPPEN

Attempting stunts increases the chance of an accident, including an overturn.

HOW TO AVOID THE HAZARD

Never attempt wheelies, jumps, or other stunts. Avoid exhibition driving.

⚠ WARNING

POTENTIAL HAZARD

Failure to inspect the ATV before operating. Failure to properly maintain the ATV.

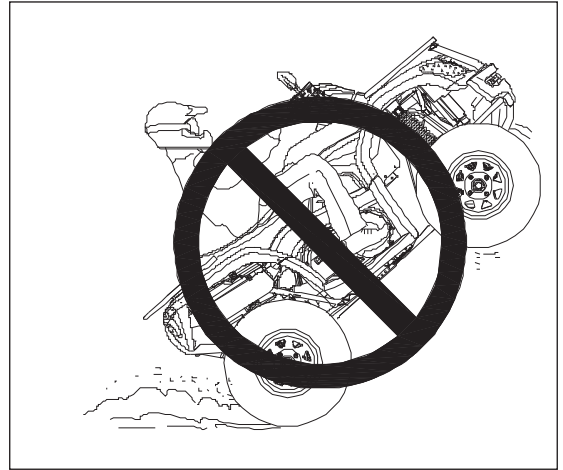

Operator Safety

WHAT CAN HAPPEN

Poor maintenance increases the possibility of an accident or equipment damage.

HOW TO AVOID THE HAZARD

Always inspect your ATV before each use to make sure it's in safe operating condition.

Always follow the inspection and maintenance procedures and schedules described in the owner's manual.

⚠ WARNING

POTENTIAL HAZARD

Removing hands from the handlebars or feet from the footrests during operation.

WHAT CAN HAPPEN

Removing even one hand or foot can reduce ability to control the vehicle or could cause loss of balance and ejection from the ATV.

If the operator's foot is not firmly planted on the footrest, it could come into contact with the rear wheels and lead to accident or injury.

Operator Safety

HOW TO AVOID THE HAZARD

Always keep both hands on the handlebars and both feet on the footrests of the ATV during operation.

⚠ WARNING

POTENTIAL HAZARD

Failure to use extra caution when operating the ATV on unfamiliar terrain.

WHAT CAN HAPPEN

Unfamiliar terrain may contain hidden rocks, bumps, or holes that could cause loss of control or overturn.

HOW TO AVOID THE HAZARD

Travel slowly and use extra caution when operating on unfamiliar terrain. Always be alert to changing terrain conditions.



Operator Safety

⚠ WARNING

POTENTIAL HAZARD

Failure to use extra caution when operating on excessively rough, slippery or loose terrain.

WHAT CAN HAPPEN

Operating on excessively rough, slippery or loose terrain could cause loss of traction or loss of control, which could result in an accident or overturn.

HOW TO AVOID THE HAZARD

Do not operate on excessively rough, slippery or loose terrain until you've learned and practiced the skills necessary to control the ATV on such terrain. Always use extra caution on rough, slippery or loose terrain.

⚠ WARNING

POTENTIAL HAZARD

Turning improperly.

WHAT CAN HAPPEN

Improper turns could cause loss of control and lead to a collision or overturn.



Operator Safety

HOW TO AVOID THE HAZARD

Always follow proper procedures or turning as described in the owner' s manual. Practise turning at slow speeds before attempting to turn at faster speeds.

Never turn at excessive speed.

WARNING

POTENTIAL HAZARD

Operating on excessively steep hills.

WHAT CAN HAPPEN

The vehicle may overturn.

HOW TO AVOID THE HAZARD

Never operate on hills too steep for the ATV or for your abilities. Never operate the ATV on hills steeper than 20°

Practice on smaller hills before attempting large hills.

Operator Safety

⚠️ WARNING

POTENTIAL HAZARD

Climbing hills improperly.

WHAT CAN HAPPEN

Improper hill climbing could cause loss of control or overturn.

HOW TO AVOID THE HAZARD

Always follow proper procedures for climbing hills as described in the owner's manual.

Always check the terrain carefully before ascending any hill.

Never operate the ATV on hills steeper than 20°. Never climb hills with excessively slippery or loose surfaces. Shift your weight forward. Never open the throttle suddenly while traveling uphill.

The ATV could flip over backwards. Never go over the top of any hill at high speed. And obstacle, a sharp drop, or another vehicle or person could be on the other side of the hill.



Operator Safety

⚠ WARNING

POTENTIAL HAZARD

Traveling downhill improperly.

WHAT CAN HAPPEN

Improperly descending a hill could cause loss of control or overturn.

HOW TO AVOID THE HAZARD

Always follow proper procedures for travelling down hills as described in the owner' s manual.



⚠ NOTE

A special technique is required when braking while traveling downhill. See page 68. Always check the terrain carefully before descending a hill. Shift your weight backward. Never travel down a hill at high speed. Avoid traveling down a hill at an angle, which would cause the vehicle to lean sharply to one side. Travel straight down the hill when possible.

Operator Safety

⚠️ WARNING

POTENTIAL HAZARD

Improperly crossing hills and turning on hills

WHAT CAN HAPPEN

Improperly crossing or turning on hills could cause loss of control or overturn.

HOW TO AVOID THE HAZARD

Never attempt to turn the ATV around on any hill until you've mastered the turning technique (on level ground) as described in the owner's manual. See page 67.

Use extra caution when turning on any hill. Avoid crossing the side of a steep hill.

WHEN CROSSING THE SIDE OF A HILL:

Always follow proper procedures as described in the owner's manual.

Avoid hills with excessively slippery or loose surfaces. Shift your weight to use uphill side of the ATV.



Operator Safety

⚠️ WARNING

POTENTIAL HAZARD

Stalling, rolling backwards or improperly dismounting while climbing a hill.

WHAT CAN HAPPEN

The vehicle could overturn.

HOW TO AVOID THE HAZARD

Maintain steady speed when climbing a hill

IF ALL FORWARD SPEED IS LOST:

Keep your weight uphill. Apply the front brake. When fully stopped, apply the rear brake as well, then shift the gear to parking.

IF THE ATV BEGINS ROLLING BACKWARDS:

Keep weight uphill. Never apply engine power.



Operator Safety

Never apply the rear brake while rolling backwards. Apply the front brake. When fully stopped, apply the rear brake as well, and shift the gear to parking.

Dismount on uphill side, or to either side if ATV is pointed straight uphill.

Turn the ATV around and remount, following the procedure described in the owner's manual. See Page 69.

WARNING

POTENTIAL HAZARD

Improperly operating over obstacles.

WHAT CAN HAPPEN

Operating over obstacles could cause loss of control or overturn.

HOW TO AVOID THE HAZARD

Before operating in a new area, check for obstacles.

Avoid operating over large obstacles such as rocks and fallen trees when possible. If unavoidable, use extreme caution and always follow proper procedures as outlined in the owner's manual.

Operator Safety

WARNING

POTENTIAL HAZARD

Skidding or sliding.

WHAT CAN HAPPEN

Skidding or sliding can cause loss of control. If the tires regain traction unexpectedly, the ATV could overturn.

HOW TO AVOID THE HAZARD

On slippery surface such as ice, travel slowly and use extra caution to reduce the chance of skidding or sliding out of control.

WARNING

POTENTIAL HAZARD

Overloading the ATV or carrying/towing cargo improperly.

WHAT CAN HAPPEN

Overloading and towing can cause changes in vehicle handling, which could lead to loss of control or an accident.

Operator Safety

HOW TO AVOID THE HAZARD

Never exceed the stated load capacity for this ATV.

Cargo should be properly distributed and securely attached. Reduce speed when carrying cargo or pulling a trailer. Allow a greater distance for braking.

Always follow the instructions in the owner's manual for carrying cargo or pulling a trailer. See page 63.

Operator Safety

WARNING

POTENTIAL HAZARD

Operation the ATV through deep or fasten-following water.

WHAT CAN HAPPEN

Tires may float, causing loss of traction and loss of control, which lead to an accident or overturn.

HOW TO AVOID THE HAZARD

Avoid operating the ATV through deep or fast-flowing water. If it is unavoidable to enter water that exceeds the recommended maximum depth (see page 70), travel slowly, balance your weight carefully, avoid sudden movements, and maintain a slow and steady forward motion. Do not make sudden turns or stops, and do not make sudden throttle changes. Wet brakes may have reduced stopping ability. Always test the brakes after leaving water. If necessary, apply brakes several times to dry out the pads.

Operator Safety

WARNING

POTENTIAL HAZARD

Improperly operating in reverse.

WHAT CAN HAPPEN

The ATV could collide with an obstacle or person, resulting in severe injury.

HOW TO AVOID THE HAZARD

Before shifting into reverse gear, always check for obstacles or people behind the ATV. When it's safe to proceed, back slowly.

WARNING

POTENTIAL HAZARD

Operating this ATV with improper tires, or with improper or uneven tire pressure.

WHAT CAN HAPPEN

Use of improper tires, or operation of the ATV with improper or uneven tire pressure, could cause loss of control or accident.

HOW TO AVOID THE HAZARD

Always use the size and type of tires specified in the owner's manual for the ATV. Always maintain proper tire pressure.

Operator Safety

⚠️ WARNING

POTENTIAL HAZARD

Operating the ATV with improper modifications.

WHAT CAN HAPPEN

Improper installation of accessories or modification of the ATV may cause changes in handling which could lead to an accident.

HOW TO AVOID THE HAZARD

Never modify the ATV through improper installation or use of accessories. All parts and accessories added to the vehicle must be genuine parts or equivalent components designed for use on this ATV and should be installed and used according to approved instructions. Consult your dealer for more information.

Operator Safety

WARNING

POTENTIAL HAZARD

Operating on frozen bodies of water.

WHAT CAN HAPPEN

Severe injury or death can result if the ATV and or the operator fall through the ice.

HOW TO AVOID THE HAZARD

Never operate the ATV on a frozen body of water.

WARNING

Leaving the keys in the ignition can lead on unauthorized use of the vehicle resulting in serious injury or death. Always remove the ignition key when the vehicle is not in use.

WARNING

After any overturn or accident, have a qualified service dealer inspect the entire vehicle for possible damage, including (but not limited to) brakes, throttle and steering systems.

Operator Safety

WARNING

Safe operation of this rider-active vehicle requires good judgement and physical skills. Persons with cognitive or physical disabilities who operate this vehicle have an increased risk of overturn and loss of control, which could result in severe injury or death.

WARNING

Exhaust system components are very hot during and after use of the vehicle. Hot components can cause serious burns and fire. Do not touch hot exhaust system components. Always keep combustible materials away from the exhaust system. Use caution when traveling through tall grass, especially dry grass.

Safety decals and locations

Warning decals have been placed on the ATV for your protection. Read and follow the instructions on each decal carefully. If a decal becomes illegible or comes off, contact your dealer to purchase a replacement.

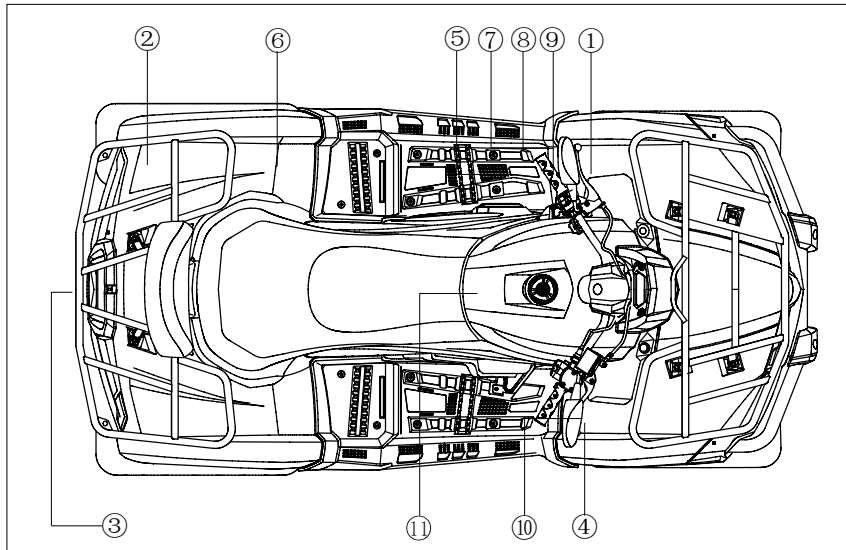

Safety decals and locations

①



CF400AU-L



CF400AU

②



CF400AU-L



CF400AU

③

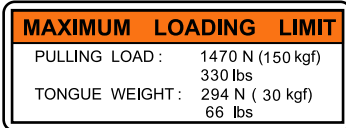

④

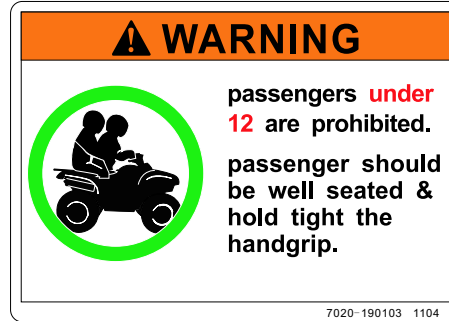

CF400AU-L



CF400AU

Safety decals and locations

⑤

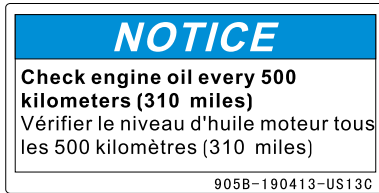

⑥

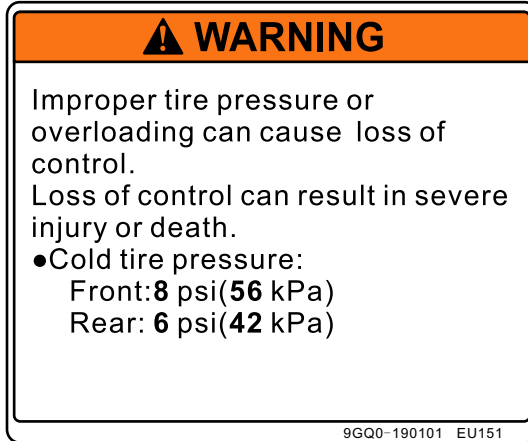

⑦



Safety decals and locations

⑧

⚠ WARNING

Improper ATV use can result in SEVERE INJURY or DEATH.



ALWAYS USE AN APPROVED HELMET AND PROTECTIVE GEAR



NEVER USE WITH DRUGS OR ALCOHOL

NEVER operate :

- without proper training or instruction.
- at speeds too fast for your skills or the conditions.

ALWAYS :

- use proper riding techniques to avoid vehicle overturns on hills and rough terrain and in turns.
- avoid paved surfaces-pavement may seriously affect handling and control.

LOCATE AND READ OWNER'S MANUAL. FOLLOW ALL INSTRUCTIONS AND WARNINGS.

CF400AU-L

⚠ WARNING

Improper ATV use can result in SEVERE INJURY or DEATH.



ALWAYS USE AN APPROVED HELMET AND PROTECTIVE GEAR



NEVER CARRY PASSENGERS



NEVER USE WITH DRUGS OR ALCOHOL

NEVER operate :

- without proper training or instruction.
- at speeds too fast for your skills or the conditions.
- with a passenger-passengers affect balance and steering and increase risk of losing control.

ALWAYS :

- use proper riding techniques to avoid vehicle overturns on hills and rough terrain and in turns.
- avoid paved surfaces-pavement may seriously affect handling and control.

LOCATE AND READ OWNER'S MANUAL. FOLLOW ALL INSTRUCTIONS AND WARNINGS.

9GQ0-190102 EU151

CF400AU

⑨

DRIVE SELECT LEVER

- Read owner's manual carefully before operating.
- ATV **MUST** be stopped before shifting select lever.
- Shifting into or from reverse or park is impossible without applying rear brake

⑩

⚠ WARNING

Turning the vehicle in 4WD-LOCK ("DIFF.LOCK") takes more effort.

Operate at a slow speed and allow extra time and distance for maneuvers to avoid loss of control.

9010-190002 US1310

⑪

⚠ WARNING



Never carry more than one passenger!
Never drive with a passenger unless passenger seat is securely in place!
Passenger must hold firmly the handgrips during riding!

CF400AU-L

Safety decals and locations

Safe riding gear

Always wear clothing suited to the type of riding. ATV riding requires special protective clothing for comfort and to reduce the chance of injury.

1. Helmet

Your helmet is the most important piece of protective gear for safe riding. An approved helmet can prevent a severe head injury.

2. Eye protection

Do not depend on sunglasses for proper eye protection. A pair of goggles or a helmet face shield offers the best protection for your eyes. They should be kept clean and be shatterproof design.

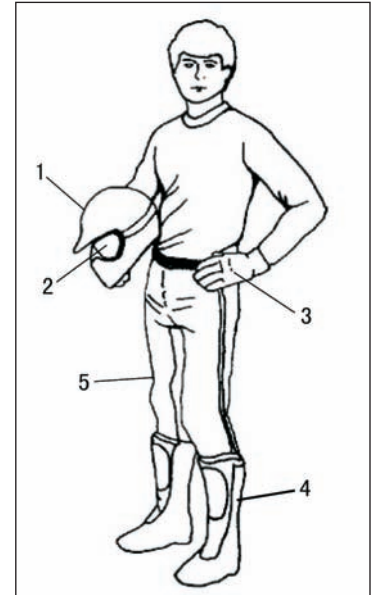

Safety decals and locations

Safe riding gear

3. Gloves

Off-road style gloves with knuckle pads are the best for comfort and protection.

4. Boots

The best footwear is a pair of strong over-the-calf boots with heels, like moto-cross boots.

5. Clothing

Always wear long sleeves and long pants to protect arms and legs. Riding pants with kneepads and a jersey with shoulder pads provide the best protection.

Features & Controls

Electrical Switches

⚠ WARNING

Pressing the override button while the throttle is open can cause loss of control, which may result in severe injury or death. Always release the throttle before pressing the override button.

① Override Button

Top speed is normally limited when operating in 4WD-LOCK. If conditions require more engine power when proceeding, press this button to override the speed limiting function. (See page 47~48 for a detailed explanation about the front diff-lock switch and its function.) Releasing the button restores the speed limiting function. While this button is depressed, the override indicator light will come on.

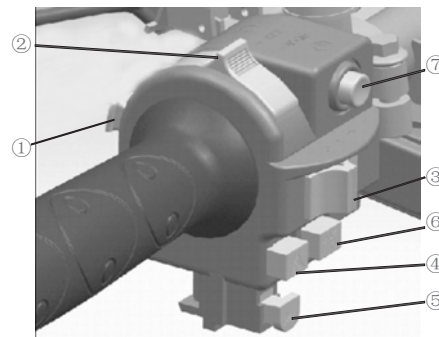

Features & Controls

② Headlight Switch

The headlight switch consists of 4 positions: “ ” 、 “ ” 、 “ OFF ” .

 : When the switch is at this position, Hi beam, front pilot light, tail light, license plate light and instrument light are on.

 : When the switch is at this position, Lo beam, front pilot light, tail light, license plate light and instrument light are on.

OFF: When the switch is at this position, tail light, license plate light are off, daytime running lamps are on.

③ Turn Switch

Move the switch to  left turn light and left turn signal indicator are on.

Move the switch to  right turn light and right turn signal indicator are on.

④ Hazard Switch

Depress the button  front turn lights, rear turn lights and turn signal indicators on dashboard are on.

CAUTION

Don't use the headlights with the engine turned off for more than 15 minutes. The battery may discharge to the point that the starter motor will not operate properly. If this should happen, remove the battery and recharge it.

Features & Controls

⑤Horn Button

Press this button, the horn will sound.

⑥Engine Stop Switch

When the switch is at  , the engine shuts off.

When the switch is at  , the engine can be started.

⑦Starter Switch

When the main switch is turned to ON, and the engine stop switch is at  , push this button to start the engine.

● Brake

Front Brake Lever

The front brake lever ② is located on the right handlebar. Put it toward the handlebar to apply the front brake.

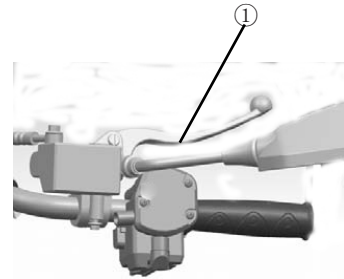

Features & Controls

Brake Pedal and Lever

Brake pedal① is located on the right side of the vehicle. Push down on the pedal to apply both the front and rear brakes.

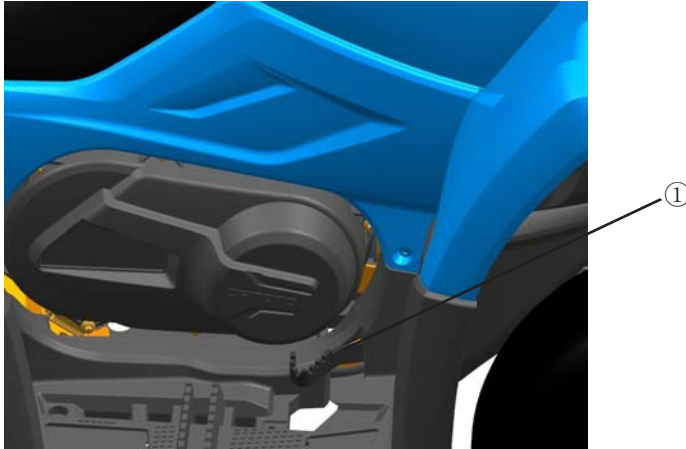

⚠ WARNING

Auxiliary parking brake can not be used in sloping road.

Features & Controls

master cylinder fluid level before riding. When squeezed, the lever or pedal should feel firm. Any sponginess would indicate a possible fluid leak or low master cylinder fluid level, which must be corrected before riding. Contact your dealer for proper diagnosis and repairs.

Brake Fluid

Check the brake fluid level in the front brake master cylinder and in the brake fluid reservoir before each use of the ATV. The front brake master cylinder is located on the right handlebar. The brake fluid reservoir is near the right passenger foot rest. The front brake fluid level can be seen through an indicator window on the side of the master cylinder. When fluid level is lower than the ① “lower” mark, refill with the same type of brake fluid.

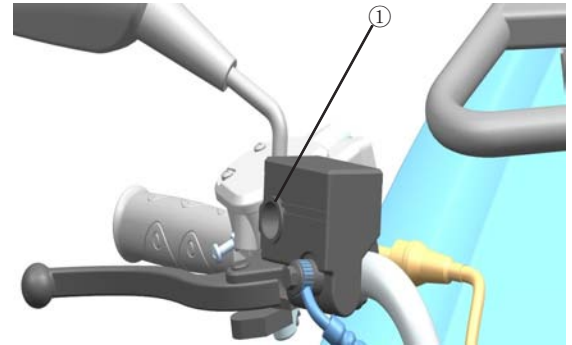

⚠ WARNING

An over-full master cylinder may cause brake drag or brake lock-up, which could result in serious injury or death. Maintain brake fluid at the recommended level. Do not overfill.

Features & Controls

⚠ NOTE

When checking the fluid level, the ATV must be on level ground with the handlebars straight. If fluid level is lower than the ① “lower” mark, add DOT3 or DOT4 brake fluid. Don't overfill.

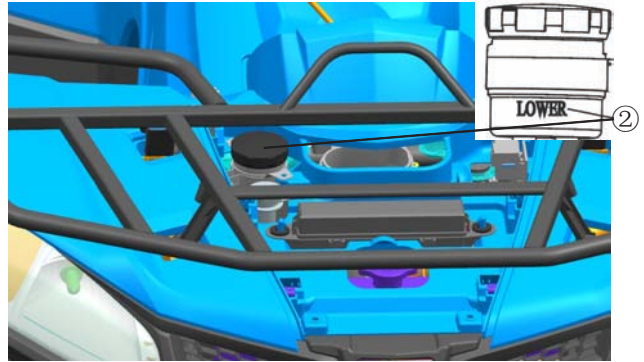

⚠ WARNING

Never store or use a partial bottle of brake fluid. Brake fluid is hygroscopic, meaning it rapidly absorbs moisture from the air. The moisture causes the drop of boiling temperature of the brake fluid, which can lead to early brake fade and the possibility of accident or severe injury. After opening a bottle of brake fluid, always discard any unused portion.

Features & Controls

Parking Brake

When parking, stop the engine and shift the gear selector Lever ② into the park position. (**CAUTION:** When shifting the transmission in PARK, always push the brake pedal) Shake the vehicle forward and backward to check if the parking brake is engaged.



Important Safeguards

- Never depend on the parking brake alone if the ATV is parked on a hill. Always block the wheels on the downhill side of the ATV to prevent rolling. It's recommended to park the ATV on a level ground.

Features & Controls

- **Fuel Tank**

Tighten the cap fuel tank with right-handed rotation in the fuel tank.

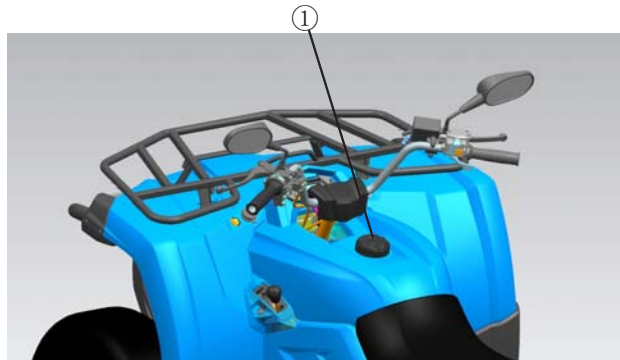

Features & Controls

• Fuel safety

⚠ WARNING

Gasoline is highly flammable and explosive under certain conditions.

- Always exercise extreme caution whenever handling gasoline.
- Always refuel with the engine stopped, and outdoors or in a well ventilated area.
- Never carry a plastic container with gasoline in the racks while riding. Static electricity between the rack and container could cause a spark.
- Do not smoke or allow open flames or sparks in or near the area where refueling is performed or where gasoline is stored.
- Do not overfill the tank. Do not fill the tank neck.
- If gasoline spills on your skin or clothing, immediately wash it off with soap and water and change clothing.
- Never start the engine or let it run in an enclosed area. Engine exhaust fumes are poisonous and can cause loss of consciousness or death in a short time.

⚠ WARNING

The engine exhaust from this product contains chemicals known to cause cancer, birth defects or other reproductive harm. Operate this vehicle only outdoors or in well-ventilated areas.

Features & Controls

● Automatic Transmission Gear Selector

The transmission gear selector ① is located on the left side of the vehicle.

- L: Low Gear
- H: High Gear
- N: Neutral
- R: Reverse
- P: Parking



When shifting among N, R, P, you must push the brake pedal.



Features & Controls

This ATV is equipped with an on-command four-wheel drive switch “2WD” /” 4WD” ① and a front diff-lock switch “LOCK” /” 4WD” ②. Select the appropriate drive according to terrain and the conditions.

- Two-wheel drive (2WD) : Power is supplied to the rear wheels only.
- Four-wheel drive (4WD) : Power is supplied to the rear and front wheels.
- Four-wheel drive with the front diff locked (4WD-LOCK): Power is supplied to the rear and front wheels when the front diff is locked. Unlike the 4WD mode, all wheels turn at the same speed.

Features & Controls

● on-command four-wheel drive switch

“2WD” / “4WD” ②: To change from 2WD to 4WD, stop the ATV, and then set the switch to “4WD”. When the ATV is in 4WD, the 4WD indicator “” will come on in the dashboard display. To change from 4WD to 2WD, stop the ATV, be sure the lever ① is moved to the front diff lock switch, and then set the switch ② to “2WD”. When the ATV is in 2WD, the 2WD indicator “” will come on in the dashboard display.

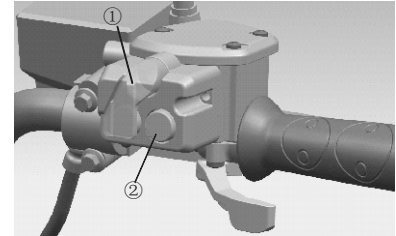

Features & Controls

Front Diff-lock Switch “LOCK” /” 4WD” ①

To lock the front diff in 4WD, make sure the on-command four-wheel-drive switch is set to 4WD, stop the ATV, move the lever ② to 2WD/4WD switch, then set the switch ① to LOCK, when the front diff is locked, the 4WD in lock indicator light “” will come on .

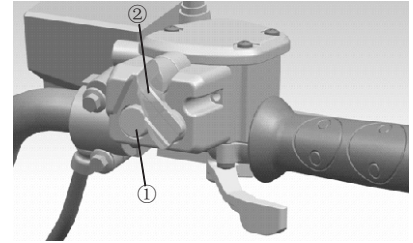

⚠ NOTE

- When the switch is set to “LOCK” , the front diff-lock indicator light will flash until the front diff is locked.
- When the indicator light is flashing, turning the handlebar left and right will help the front gear lock to engage.
- Riding before the front diff lock is properly engaged (e.g., when the indicator light is flashing) will cause the engine speed to be limited until engagement is complete.
- When the ATV is in 4WD-LOCK, the maximum traveling speed is limited to 35 km/h (22 mph) . However, if conditions require full engine power to be available, depress the override switch to disable the 4WD-LOCK speed limiter.

Features & Controls

• Throttle Lever

Once the engine is running, movement of the throttle lever will increase the engine speed. Regulate the speed of the machine by varying the throttle position. Because the throttle is spring-loaded, the machine will decelerate, and the engine will return to an idle any time the hand is removed from the throttle lever. Before starting the engine, check the throttle to be sure it is operating smoothly. Make sure it returns to the idle position as soon as the lever is released.

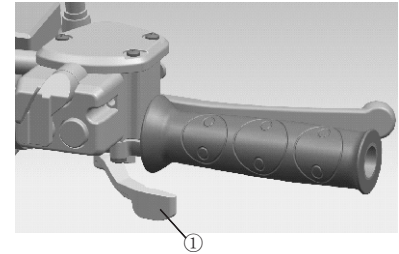

⚠ CAUTION

Check the operation of the throttle lever before you start the engine. If it does not work smoothly, check for the cause. Correct the problem before riding the ATV. Consult your dealer if you can't find or solve the problem yourself.

Features & Controls

Speed Limiter

The speed limiter keeps the throttle from fully opening, even when the throttle lever is pushed to the maximum. Turning in the ② limits the maximum engine power available and decreases the maximum speed of the ATV.

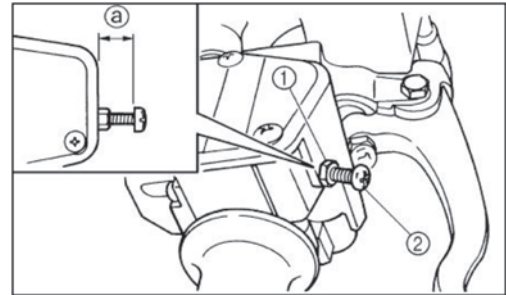

⚠ CAUTION

Do not turn the adjusting screw out more than 12 mm (0.47 in). Always make sure the throttle lever free play is adjusted to very easily (0.12–0.20 in).

Features & Controls

● Main Switch

Functions of the respective switch positions are as follows:

- Ⓚ : The engine can be started only at this position and the headlights and taillight come on when the light switch is on. The key can not be removed in this position.
- ⊗ : All electrical circuits are switched off. The key can be removed in this position.

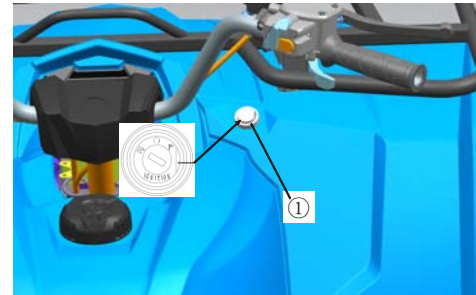

Indicator and Warning Lights

- ①Turning Indicators: includes Left turning indicator and right turning indicator. Move the switch to ← right turn light and right turn signal indicator are on.
Move the switch to ⇒ left turn light and left turn signal indicator are on.
- Depress the button ▲ front turn lights, rear turn lights and turn signal indicators on dashboard are on. Please check the Page 43 for reference.

②Pilot Light Indicator ≡○、≡○、≡○

This indicator light comes on when moving the head light switch to High Beam Indicator, lower Beam Indicator and Pilot Light Indicator. Please check the Page 43 for reference.

③High Beam Indicator: ≡○

This indicator light comes on when moving the head light switch to ≡○

④Gear Indicators: L, H, N, R, P

Lo Gear Indicator “L”

This indicator light comes on when the gear selector is in the L position.

Hi Gear Indicator “H”

This indicator light comes on when the gear selector is in the H position.

Neutral Indicator “N”

This indicator light comes on when the gear selector is in the N position.

Reverse Gear Indicator “R”

This indicator light comes on when the gear selector is in the R position.

Park Indicator “P”

This indicator light comes on when the gear selector is in the P position.

Please check the Page 44 for reference.

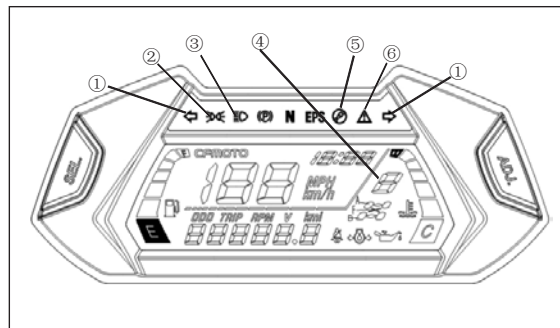

①Turning Indicators
②Pilot Light Indicator
③High Beam Indicator

④Gear Indicators
⑤ EFI Indicator
⑥ Override Indicator

⑤ EFI Indicator :

This indicator light comes on when troubles occur in EFI system (Refer to page150 for detailed information)

⑥ OVERRIDE INDICATOR

This indicator light comes on when pressing the override switch. Always exercise caution to use override button.

Dashboard

1. Oil pressure warning light:When the engine lubrication oil pressure is abnormal, the light is on, and off when it's normal.

2. Wheel drive indicator:Corresponds to the drive method of the right handlebar. When it's in 2WD, it shows “” ,

When it's in 4WD, it shows “” ,

When it's in 4WD +LOCK, it shows “” , Refer to Page 44.

Tip: Only after the drive method have been switched will the wheel light indicator will on because the front gear case has the synchronizing apparatus.

3. Fuel gauge: show the gas remain in the tank, F means it.s full, E means the stand-by gas . And when the petrol indicator enter the red area, which means the gas that remained can drive for 50KM at most, need to be added as soon as possible.

4. Speed Indication Devices: Indicate the speed in number way,the work method can switch between metric and inch. Refer to Page 44.

5. Mileage display: Indicate the mileage in number way,the work method can switch between metric and inch.

Refer to Page 44.

6. EPS indicator:When the bike is equipped with EPS system, the indicator light is on. Its working method and content refer to Page 150.

7. Coolant temperature gauge: Shows the current coolant temperature, C is the low temperature area, H is the high temperature area, Both overflow and overhigh are abnormal, Idle warm machine is need when it's too cold, and park the bike when it's too hot to prevent the coolant from being boiling. Keep the coolant temperature in a normal range.

⚠ NOTE

If the ATV drive for a long time or in a slope with heavy load, which may lead to the engine overheat.

8. Clock indicator : Display the current time, whose method and adjustment refer to Page 44.

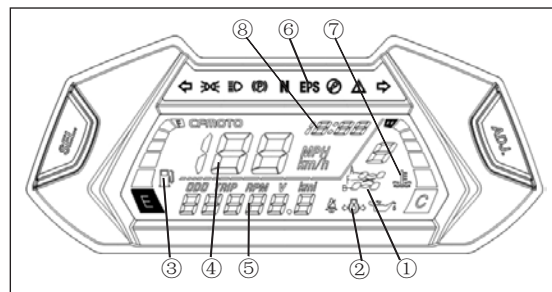

- ① Wheel drive indicator
- ② Oil pressure warning light
- ③ Fuel gauge
- ④ Speed Indication Devices
- ⑤ Mileage display
- ⑥ EPS indicator
- ⑦ Coolant temperature gauge
- ⑧ Clock indicator

Features & Controls

Dashboard Setting/Adjustment list

Item	Shows and display	key-operated switch	Result
Metric system/British system exchange	Speed/Mileage	Long press Key ①	Metric system←→British system
Mileage display exchange	Mileage ODO	Short press Key ①	ODO→TRIP→RPM→ODO
Trip mileage cleaning	Mileage TRIP	Long press Key ①	Trip mileage zero clearing
Time/hours adjustment	Time display	Short press Key ②	Hours progressive increase(0~12)
Time/Mintues adjustment	Time display	Long press Key ②	Mintues progressive increase (0~59)



Operation

Break-In Period

The break-in period for your new ATV is very important, it is not only a simple action for you, which is as important as a proper break-in stated in manual. Careful treatment of a new engine will result in more efficient performance and longer life for the engine. Perform the following procedures carefully.

Operation

⚠ CAUTION

Do not load or tow cargo during the first 20 hours of use, do not operate at full throttle. It may damage engine parts or decrease engine life if excessively increase throttle during the first 20 hours of use.

Do not run engine with throttle over 1/2 open during the first 10 hours of use. Do not run engine with throttle over 3/4 open during the first 10 to 20 hours of use.

Operate this ATV in normal condition after break-in period.

Use of any oils other than those recommended may cause serious engine damage. We recommend the use of special oil for 4-stroke engine: SAE 15W-40/SG.

Perform the following procedures before operation:

1. Fill the fuel tank with gasoline.
2. Put ATV on a level surface to check the oil level. Add recommended oil if necessary to maintain the oil level between the minimum and maximum level marks of the dipsticks.
3. Drive slowly at first. Select an open area that allows room to familiarize yourself with vehicle operation and handling.
4. Vary throttle positions. Do not operate at sustained idle.
5. Perform regular checks on fluid levels, controls and areas outlined on the daily pre-ride inspection checklist. See page 65.

Operation

6. Pull only light loads.
7. During the break-in period, change both the oil and oil filter at 20 hours or 750km .

● Pre-Ride Inspection

⚠ WARNING

If a proper inspection is not done before each use, severe injury or death could result. Always inspect the vehicle before each use to ensure it is in proper operating condition.

Pre-Ride Checklist		
Item	Remarks	See Page
Brake system/ lever travel	Ensure proper operation	45, 118
Brake fluid	Ensure proper level	48
Front suspension	Inspect, lubricate if necessary	129
Rear suspension	Inspect, lubricate if necessary	129

Operation

Pre-Ride Checklist		
Item	Remarks	See Page
	necessary	
Steering	Ensure free operation	
Tires	Inspect condition and pressure	154
wheels / fasteners	Inspect, ensure fastener tightness	122, 123
Frame nuts, bolts, fasteners	Inspect, ensure fastener tightness	
Fuel and oil	Ensure proper levels	98, 99
Coolant level	Ensure proper levels	104, 105
Coolant hoses	Inspect for leaks	
Throttle	Ensure proper operation	114
Gear shifting	Ensure proper operation	
Indicator lights/ switches	Ensure proper operation	58 ~ 60

Operation

Pre-Ride Checklist		
Item	Remarks	See Page
Air filter	Inspect, clean	110, 111
Air box sediment tube	Drain deposits whenever visible	
Headlamp	Check operation	126, 127
Brake light/tail lamp	Check operation	128
Riding gear	Wear helmet, gloves, protective clothing	41, 42

Operation

Starting the Engine

Starting a Cold Engine

⚠ WARNING

Engine exhaust contains poisonous carbon monoxide and can cause loss of consciousness resulting in severe injury or death. Never run an engine in an enclosed area.

⚠ CAUTION

Operating the vehicle immediately after starting could cause engine damage. Allow the engine to warm up for several minutes before operating the vehicle.

Starting a Cold Engine

1. Apply the rear brake pedal.
2. Turn ignition switch to “”, turn stop switch to “ ON ” .
3. Shift gear selector into the neutral position.

⚠ NOTE

- When the gear selector is in neutral position, if indicator light on dashboard does not come on, ask your dealer to inspect its electric circuit or adjust gear-shifting system.

Operation

- Engine can be started in any gear if rear brake pedal is applied. However it is recommended to shift into neutral or park before starting the engine.
4. Completely close throttle lever and start the engine by pushing the start switch.
- If the engine fails to start, release the start switch, then push the start switch again. Pause a few seconds before the next attempt. Each cranking should be as short as possible to preserve battery energy. Do not crank the engine more than 10 seconds on each attempt.
 - If the battery is discharged, disassemble the battery to recharge.
5. Continue warming up the engine until it idles smoothly before starting the ATV.

CAUTION

See the “Break-In Period” section prior to operating the engine for the first time.

Operation

• Gear selector operation and reverse driving

⚠ CAUTION

Before shifting, you must return the throttle lever to the closed position and stop the ATV. Otherwise, the transmission may be damaged.

Shifting: Neutral to High

1. Return the throttle lever to the closed position and stop the ATV.
2. shift to "H"(High) by moving the gear selector along the shift guide.



⚠ NOTE

Make sure that the gear selector is completely shifted into position.

3. Open the throttle lever gradually.

Shifting: High to Low

1. Return the throttle lever to the closed position and stop the ATV completely.
2. Apply the rear brake pedal, shift to Low by moving the gear selector along the shift guide.

Operation

Shifting: Low to High

1. Return the throttle lever to the closed position and stop the ATV completely.
2. Shift to "H"(High) by moving the gear selector along the shift guide.

Shifting: Neutral(N) to Reverse®;

⚠ NOTE

The gear selector cannot be shifted into reverse(R) without applying the rear brake.

1. Return the throttle lever to the closed position and stop the ATV completely.
2. Apply the rear brake pedal, Shift the gear selector from "N" (neutral) to "R"(reverse) by moving along the shift guide.



Operation

NOTE

- Ⓐ When in reverse, the reverse indicator light should be on.
 - Ⓑ The indicator light should be on in accordance with actual gear position, if the light does not come on, ask your dealer to inspect.
 - Ⓒ Due to the synchronizing mechanism in the engine, the light may not come on until ATV starts moving.
4. Check behind for people or obstacles, then release the rear brake pedal.
 5. Open the throttle lever gradually and continue to watch rear while moving backward.

WARNING

When you shift into reverse, make sure there are no obstacles or people safe behind you. When it is safe to proceed, go slowly.

shifting: Reverse to Park

1. Return the throttle lever to the closed position and stop the ATV completely.
2. Apply the rear brake pedal, Shift from reverse to park by moving the gear selection along the shift guide.

Operation

● HAULING CARGO

⚠ WARNING

Overloading the vehicle or carrying or towing cargo improperly can alter vehicle handling and may cause loss of control or brake instability. Always follow these precautions when hauling cargo:

- Never exceed the stated load capacity for this vehicle.
- Reduce speed.
- When operating over rough or hilly terrain, reduce speed and cargo to maintain stable driving conditions.
- Weight distribution in the rear rack should be as far forward and as low as possible. Carrying a high load raises the center of gravity and creates a less stable operating condition. Reduce load weight when cargo is high. When handling off-centered loads that cannot be centered, secure the load and operate with extra caution.
- All loads must be secured before operation. Unsecured loads may shift and create unstable operating conditions, which could result in loss of control of the vehicle. Always be sure that the rear rack is lowered.

Operation

- When operating with loads extending beyond the rack. Stability and maneuverability may be adversely affected, causing the machine to overturn.
- Carrying a load on only the front rack or the rear rack may cause an imbalanced condition and increases the possibility of vehicle overturn. Balance loads proportionally between the front rack and the rear rack, but do not exceed the stated load capacity.
- Use extreme caution when applying brakes with a loaded vehicle. Avoid terrain or situations that may require backing down- hill.
- Always attach the tow to the hitch point.
- The vehicle should never exceed 10 mph (16 km/h) while towing a load on a level surface. Vehicle speed should never exceed 5mph (8 km/h) when towing loads in rough terrain, while cornering, or while ascending or descending a hill.
- Do not obstruct the headlight when loading the front rack.

Load Distribution

Your ATV has been designed to carry or tow a certain amount of load. Always read and understand the load distribution warnings listed on the warning labels, and never exceed the specified weights. Cargo weight should be mounted as low as possible. When operating over rough or hilly terrain, reduce speed and cargo to maintain stable driving conditions.

Operation

1. Always load the cargo as far forward as possible.
2. Always operate the vehicle with extreme caution whenever hauling or towing loads. Balance, handling, and control may be affected.
3. Slow down.

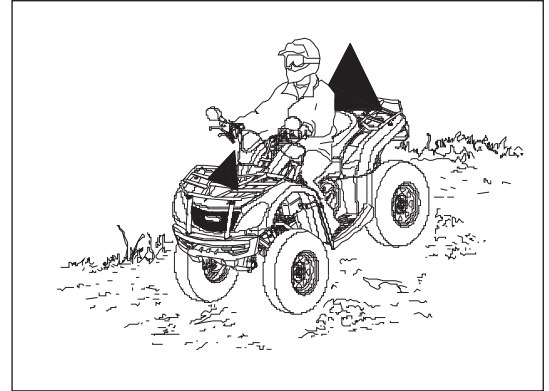

Driving Safely

Driving Procedures

1. Sit upright with both feet on the footrests and both hands on the handlebars.
2. Start the engine and allow it to warm up, apply the brakes, then shift the transmission into gear.
3. Check your surroundings and determine your path of travel.
4. Release the brakes.

Operation

5. Slowly depress the throttle with your right thumb and begin driving. Vehicle speed is controlled by the amount of throttle opening.
6. Drive slowly. Practice maneuvering and using the throttle and brakes on level surfaces.

Making Turns

To make a turn, steer in the direction of the turn, leaning your upper body to the inside of the turn while supporting your weight on the outer footrest. This technique alters the balance of traction between the wheels, allowing turn to be made smoothly. The same leaning technique should be used for turning in reverse.

⚠ NOTE

Practice making turns at slow speeds before attempting to turn at faster speeds.

⚠ WARNING

Turning at sharp angles or at excessive speeds can result in vehicle overturn and lead to serious injury. Avoid turning at sharp angles. Never make turns at high speeds.



Operation

Driving on Slippery Surfaces

Whenever riding on slippery surfaces such as wet trails or loose gravel, or during freezing weather, follow these precautions:

1. Slow down when entering slippery areas.
2. Maintain a high level of alertness, reading the trail and avoiding quick, sharp turns which can cause skids.
3. Correct a skid by turning the handlebars in the direction of the skid and shifting your body weight forward.
4. Driving with AWD engaged can assist in controlling the vehicle in slippery areas.

⚠ CAUTION

Severe damage to drive train may occur if the AWD is engaged while the wheels are spinning.

Always engage AWD when the wheels have traction or are at rest.

⚠ WARNING

Failure to exercise care when operating on slippery surfaces can result in loss of tire traction and cause loss of control, accident, and serious injury or death. Never apply the brakes during a skid. Do not operate on excessively slippery surfaces. Always reduce speed and use additional caution.

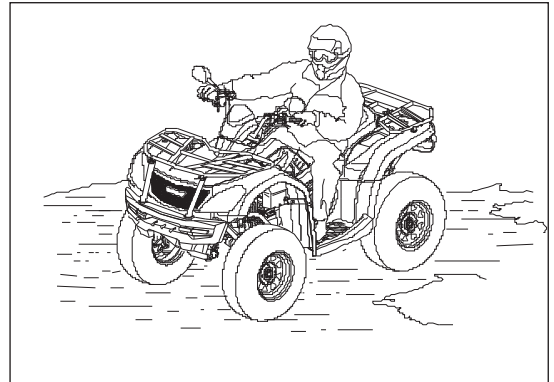

Operation

Driving Uphill

Whenever traveling uphill, follow these precautions:

1. Always travel straight uphill.
2. Avoid steep hills (20° maximum).
3. Keep both feet on the footrests.
4. Shift your weight forward.
5. Proceed at a steady rate of speed and throttle opening.
6. Remain alert and be prepared to take emergency action. This may include quick dismounting of the vehicle.

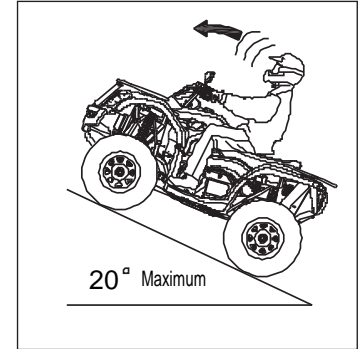

If all forward speed is lost:

Keep your weight uphill.

Apply the front brake. When fully stopped, apply rear brake as well, then shift gear selector into park position.

If the ATV begins rolling backwards:

Keep your weight uphill. Never apply engine power. Never apply the rear brake while rolling backwards. Apply the front brake. When fully stopped, apply the rear brake as well, and then shift gear selector into park position.

Dismount on uphill side, or to either side if ATV is pointed straight uphill. Turn the ATV around and remount, following the procedure described on page 81.

Operation

⚠️ WARNING

Braking and handling are greatly affected when operating in hilly terrain. Improper procedure could cause loss of control or overturn and result in serious injury or death.

Avoid climbing steep hills (20 maximum) .

Use extreme caution when operating on hills, and follow proper operating procedures outlined in the owner s manual.

Sidehilling

⚠️ WARNING

Improperly crossing hills or turning on hills can result in loss of control or vehicle overturn, resulting in severe injury or death. Avoid crossing the side of a hill when possible. Follow proper procedures as outlined in the owner s manual. Sidehilling can be a dangerous type of driving and should be avoided if at all possible. If you do enter into a situation where sidehilling is necessary, follow these precautions:

1. Slow down.
2. Lean into the hill, transferring your upper body weight toward the hill while keeping your feet on the footrests.

Operation

3. Steer slightly into the hill to maintain vehicle directions.

⚠ NOTE

If the vehicle begins to tip, quickly turn the front wheel downhill, if possible, or dismount on the uphill side immediately!

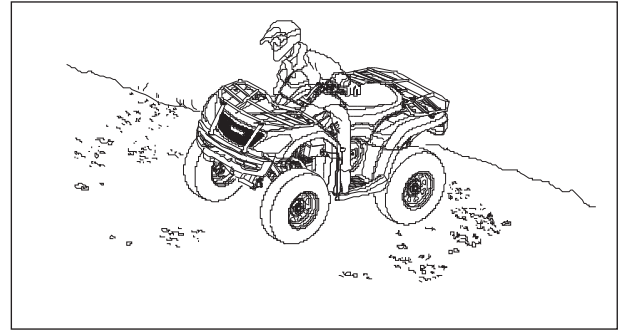

Driving Downhill

Whenever descending a hill, follow these precautions:

1. Proceed directly downhill.
2. Shift your weight to the rear of the vehicle.
3. Slow down.
4. Apply the brakes slightly to aid in slowing.

Familiarize yourself with operation of the auxiliary rear brakelever.



Operation

⚠️ WARNING

Excessive speed can cause loss of control and lead to serious injury or death. Always operate slowly when traveling downhill.

Turning Around on a Hill

⚠️ WARNING

Improper hill climbing procedures could cause loss of control or overturn and result in serious injury or death.

Avoid climbing steep hills (20° maximum).

Use extreme caution when operating on hills, and follow proper operating procedures outlined in the owner's manual. If the vehicle stalls while climbing a hill, never back it down the hill!

One maneuver that can be used when it's necessary to turn around while climbing a hill is the K-turn:

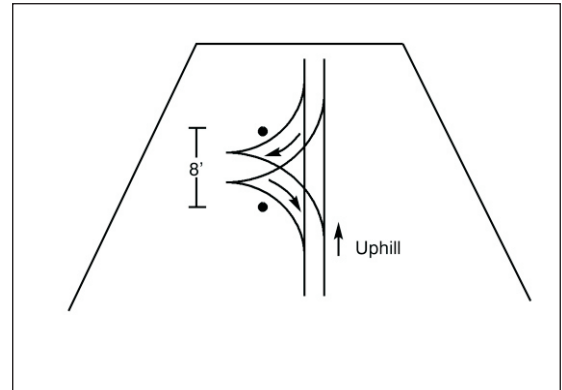

Operation

1. Stop and shift the gear selector lever to the parking position while keeping body weight uphill.
2. Shut off the engine.
3. Dismount on the uphill side of the vehicle, or on the left if the vehicle is pointing straight uphill.
4. Staying uphill of the vehicle, turn the handlebars full left.
5. While holding the brake lever, shift the gear selector lever to the low gear position and slowly allow the vehicle to roll around to your right until it' s pointing across the hill or slightly downward.
6. Shift the gear selector lever to the parking position and remount the vehicle from the uphill side, keeping body weight uphill.
7. Restart the engine, while holding the brake lever, shift the gear selector lever to low gear position.
8. Release the brake and proceed slowly, controlling speed with the brake, until the vehicle is on more level ground.

Driving Through Water

Your ATV can operate through water with a maximum recommended depth equal to the bottom of the footrests . Follow these procedures when operating through water:

1. Determine water depths and current before crossing.
2. Choose a crossing where both banks have gradual inclines.

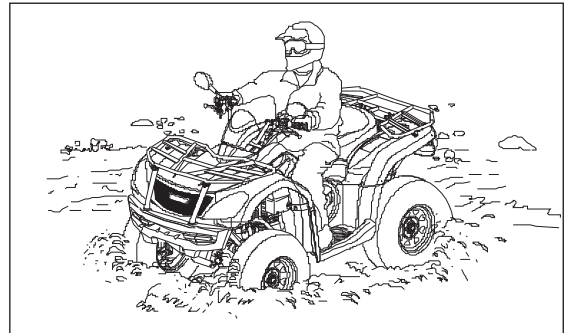

Operation

3. Proceed slowly, avoiding rocks and obstacles if possible.
4. After crossing, dry the brakes by applying light pressure to the lever until braking action is normal.

⚠ NOTE

Avoid operating the vehicle through deep or fast-flowing water. If you cannot avoid water that exceeds the recommended maximum depth, go slowly, balance your weight carefully, avoid sudden movements, and maintain a slow and steady forward motion. Do not make sudden turns or stops, and do not make sudden throttle changes.

After running the vehicle in water, it's critical to have it serviced as outlined in the maintenance chart. See page 117. The following areas need special attention: engine oil, transmission oil, front and rear gear cases and all grease fittings.

⚠ NOTE

If water has been ingested into the CVT, follow the procedure on page 113 for drying out the CVT. If your vehicle becomes immersed, and it's impossible to take it to your dealer before starting it, follow the steps described on page 129. Have the vehicle serviced by your dealer promptly.

Operation

⚠ WARNING

Major engine damage can result if the vehicle is not thoroughly inspected after operation in water. Perform the services outlined in the maintenance chart.

If your vehicle becomes immersed or is operated in water that exceeds the footrest level, take it to your dealer for service before starting the engine.

Driving Over Obstacles

Be alert! Look ahead and learn to read the terrain. Be constantly alert for hazards such as logs, rocks and low hanging branches.

⚠ WARNING

Severe injury or death can result if your vehicle comes in contact are immediately visible.

Travel with caution in unfamiliar terrain.

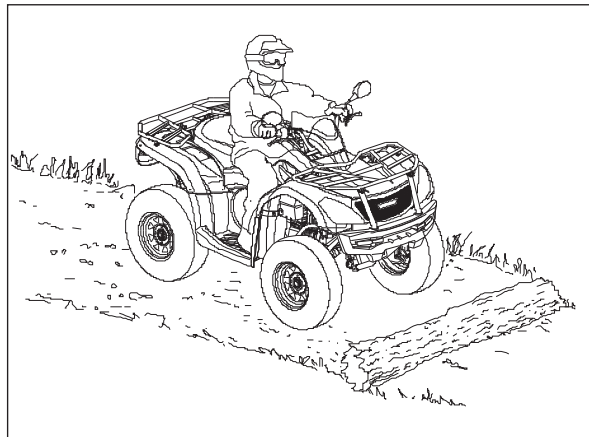

Operation

Driving in Reverse

Follow these precautions when operating in reverse:

1. Always avoid backing downhill.
2. Back slowly.
3. When in reverse, apply the brakes lightly for stopping.
4. Avoid turning at sharp angles in reverse.
5. Never open the throttle suddenly while backing.

⚠WARNING

Failure to use caution when operating in reverse can result in serious injury or death. Before shifting into reverse, always check for obstacles or people behind the vehicle. When it's safe to proceed, back slowly. Do not use the override switch unless additional power is required for vehicle movement. Use with caution. Avoid backing on inclines, and avoid turning at sharp angles.

⚠NOTE

Your ATV is equipped with a reverse speed limiter. The override button can not be used. Do not operate at wide open throttle. Open the throttle just enough to maintain a desired speed.

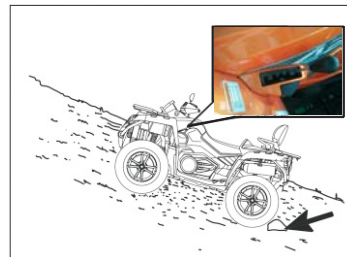
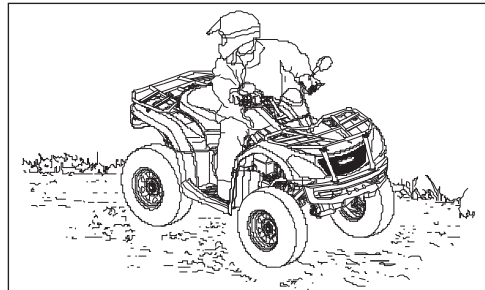

Operation

⚠ WARNING

Excessive throttle operation while in the speed limit mode may cause fuel to build in the exhaust, resulting in engine popping and/or engine damage. Engine brake will be executed and rear output shaft locked when gear on the parking position.

Parking on an Incline

Avoid parking on an incline if possible. If it is unavoidable, follow these:

1. Turn the engine off.
2. Place the gear selector to parking position.
3. Always block the rear wheels on the downhill side as illustrated.

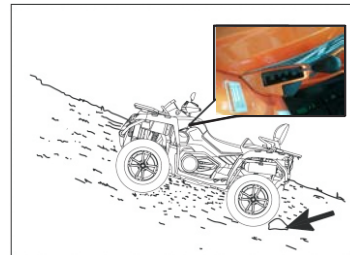

Operation

TURNING YOUR ATV

To achieve maximum traction while riding in 2WD or 4WD, the two rear wheels are mounted solidly on one axle and turn together at the same speed. Furthermore, when riding in 4WD-LOCK (DIFF. LOCK), the front wheels also turn together at the same speed. Therefore, unless the wheel on the inside of the turn is allowed to slip or lose some traction, the ATV will resist turning. A special turning technique must be used to allow the ATV to make turns quickly and easily. It is essential that this skill be learned first at low speed.

WARNING

Always follow proper procedures for turning as described in this Owner s Manual. Practice turning at low speeds before attempting to turn at faster speeds. Do not turn at speeds too fast for your skills or the conditions. Operate at a slow speed and allow extra time and distance for maneuvers when in 4WD- LOCK (DIFF. LOCK).

As you approach a curve, slow down and begin to turn the handlebars in the desired direction. As you do so, put your weight on the footboard to the outside of the turn (opposite your desired direction) and lean your upper body into the turn. Use the throttle to maintain an even speed through the turn. This maneuver will let the wheel on the inside of the turn slip slightly, allowing the ATV to make the turn properly.

Operation

This procedure should be practiced at slow speed many times in a large area with no obstacles. If an incorrect technique is used, your ATV may continue to go straight. If the ATV doesn't turn, come to a stop and then practice the procedure again. If the riding surface is slippery or loose, it may help to position more of your weight over the front wheels by moving forward on the seat. Once you have learned this technique you should be able to perform it at higher speeds or in tighter curves. Improper riding procedures such as abrupt throttle changes, excessive braking, incorrect body movements, or too much speed for the sharpness of the turn may cause the ATV to tip. If the ATV begins to tip over to the outside while negotiating a turn, lean more to the inside. It may also be necessary to gradually let off on the throttle and steer to the outside of the turn to avoid tipping over. Remember: Avoid higher speeds until you are thoroughly familiar with the operation of your ATV.

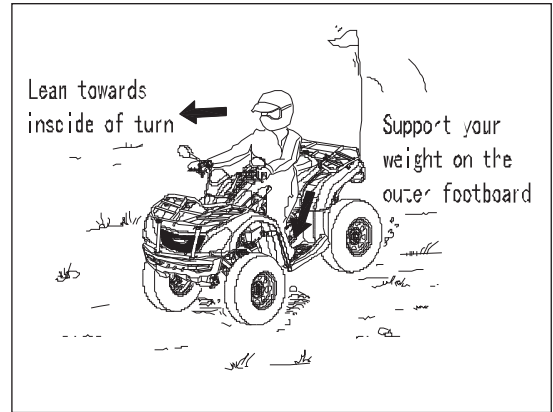

Maintenance & Lubrication

Accessories

Auxiliary power outlets provide 12V power for operating accessories such as hand held spot lights. Please consult with your dealer.

Periodic maintenance chart

Careful periodic maintenance will help keep your vehicle in the safest, most reliable condition. Inspection, adjustment and lubrication of important components are explained in the periodic maintenance chart.

Inspect, clean, lubricate, adjust, and replace parts as necessary. When inspection reveals the need for replacement parts, please use genuine parts available from your dealer.

⚠ NOTE

Service and adjustments are critical. If you're not familiar with safe service and adjustment procedures, have a qualified dealer perform these operations.

Maintenance intervals in the following chart are based upon average riding conditions and an average vehicle speed of approximately 10 miles or 20 Km per hour. Vehicles subjected to severe use must be inspected and serviced more frequently

Maintenance & Lubrication

Severe use definition

- Frequent immersion in mud, water or sand
- Racing or race-style high RPM use
- Prolonged low speed, heavy load operation
- Extended idle
- Short trip cold weather operation

Pay special attention to the oil level. A rise in oil level during cold weather can indicate contaminants collecting in the oil sump or crankcase. Change oil immediately if the oil level begins to rise. Monitor the oil level, and if it continues to rise, discontinue to use and determine the cause or see your dealer.

Key points of maintenance chart

- ▶ Perform these procedures more often for vehicles subjected to severe use.
- Have an authorized dealer perform these services.

DANGER

Improperly performing the procedures marked with a “■” could result in component failure and lead to serious injury or death. Have an authorized dealer perform these services.

Maintenance & Lubrication

Periodic maintenance chart

Perform all services at whichever maintenance interval comes first.

Item		Maintenance Interval (Whichever comes first)			Remarks
		Hour	Calendar	Miles(km)	
■	Steering		Pre-Ride		Make adjustments as needed. See Pre-Ride Checklist on page 65.
▶	Front suspension		Pre-Ride		
▶	Rear suspension		Pre-Ride		
	Tire		Pre-Ride		
▶	Break fluid level		Pre-Ride		
▶	Brake lever/pedal travel		Pre-Ride		
	Brake systems		Pre-Ride		
	Wheels/fasteners		Pre-Ride		
	Frame fasteners		Pre-Ride		
▶	Engine oil level				
▶	Air inlet, air filter				Inspect and clean if necessary
▶	Air box sediment tube				Drain deposits when visible

Maintenance & Lubrication

Periodic maintenance chart

	Coolant	50h	Daily	1500	Check level daily,change coolant Every 2 years or 6000km/200h, but initial check should be done after 20h or 750km.
	Headlight/tail light		Daily		Check operation; apply dielectric grease if replacing
▶	Air filter element	50h	—	1500	Inspect. Clean every 1000km or 100 hours. Replace initial replacement should be done after 750km or 20h .
	CVT outlet pipe		Every week		Drain water as needed, check often if operating in wet conditions
▶	Brake pad wear	10h	Monthly	100	Inspect periodically
	Battery	20h	Monthly	200	Check terminals; clean; test
▶	Front gear case oil	25h	Monthly	250	Inspect level; change yearly
▶	Rear gear case oil	25h	Monthly	250	Inspect level; change yearly
▶	Transmission oil	25h	Monthly	250	Inspect level; change yearly

Maintenance & Lubrication

Periodic maintenance chart

▶	General lubrication	50h	3M	500	Lubricate all fittings, pivots, cables, etc.
	Steering knuckle	50h	6M	500	Inspect, lubricate, adjust
■	Steering handlebar	50h	6M	500	lubricate
▶	Front suspension	50h	6M	500	lubricate
▶	Rear suspension	50h	6M	500	lubricate
	Gearshift	28h	1M	500	Inspect, lubricate, adjust
■	Throttle cable/ Switch	50h	6M	500	Inspect; adjust; lubricate; replace if necessary
	Drive belt	50h	—	1500	Inspect; adjust; replace if necessary. Replace for every 3000 km
	Cooling system	50h	6M	500	Inspect coolant strength seasonally; pressure test system yearly

Maintenance & Lubrication

Periodic maintenance chart

▶	Engine oil change	100h	12M	3000	Perform a break-in oil change at 20 hours/750km
▶	Fuel hose	100h	—	1000	Inspect routing, condition, Replace high-pressure fuel hose every 4 years
■	Valve clearance	100h	12M	3000	Inspect, Adjust, Initial:750km, or 20h
■	Fuel system	100h	12M	1000	Inspect cap of fuel tank, fuel pump and fuel relay.
■	Oil filter	100h	12M	3000	Initial change: 750km or 20h
▶	Radiator	200h	24M	3000	Inspect; clean external surfaces
▶	Cooling hoses	100h	—	1000	Inspect. Initial: 300km or 10h
▶	Engine mounts	100h	12M	3000	Inspect. Initial: 300km or 10h
	Exhaust pipe and muffler	100h	12M	1000	Inspect

Maintenance & Lubrication

Periodic maintenance chart

■	Ignition coil	100h	12M	1000	Inspect and replace as needed
■	ECU	100h	12M	1000	Inspect and replace as needed
▶	Wirings and cables	100h	12M	1000	Inspect for wear, routing, security; apply dielectric grease to connectors subjected to water, mud, etc.
■	CVT(drive and driven pulley)	100h	12M	3000	Inspect; clean; replace worn parts
■	Wheel bearings	100h	12M	1600	Inspect and replace as necessary
▶	Brake fluid	200h	24M	2000	Change every two years
	Spark plug	100h	12M	3000	Initial: 750km or 20h. Replace every 6000km
	Idle condition				Inspect every component. 1500±100r/min
■	Toe adjustment				Inspect periodically; adjust when parts are replaced
▶	Auxiliary brake				Inspect daily; adjust as needed
■	Headlight aim				Adjust as needed

Maintenance & Lubrication

Recommended Lube

Check and lubricate all components at the intervals outlined in the Periodic Maintenance Chart beginning on page 91. Items not listed in the chart should be lubricated at the General Lubrication interval.

Key points of lubrication chart

- ▶ More often under severe use, such as wet or dusty conditions
- ★ All Season Grease
- Use U-Joint Lube every 500 miles, before long periods of storage, or after pressure washing or submerging

Maintenance & Lubrication

Items	Lube	Methods
Engine oil	SAE15W-40/SG	Use dipstick to check oil level
Brake fluid	DOT3 or DOT4	Keep level between Upper and Lower line, see page 47
Front gear case oil	SAE15W/40 SG or SAE80W/90 GL-4	See page 102
Rear gear case oil	SAE15W/40 SG or SAE80W/90 GL-4	See page 101
Ball Joint	Grease	

Maintenance & Lubrication

Lubrication recommendations

Engine oil

Always check and change the engine oil at the intervals outlined in the Periodic Maintenance Chart beginning on page 93 and 94. Always change the oil filter whenever changing oil.



Engine oil check

1. Remove plastic cover ① as right picture shows.
2. Position the ATV on a level surface.
3. Start the engine and let it idle for 20-30 seconds. Stop the engine.
4. Wait a few minutes until the oil settles.
5. Take oil dipstick out from ① and wipe off area ② of dipstick with a clean rag.
6. Insert the dipstick in the oil filler hole and screwing it in, then remove it again to check the oil level.

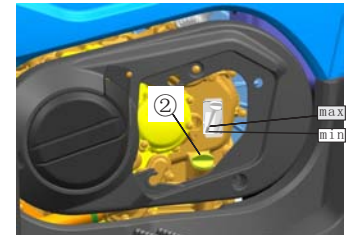

▲ NOTE

The engine oil should be between the upper and lower limit marks.

Maintenance & Lubrication

Engine oil check

7. If the engine oil is at or below the lower limit mark, add sufficient oil of the recommended type to raise it to the correct level.
8. Insert the dipstick into the oil filler hole, and then tighten it.
9. Install plastic cover ①。

To change engine oil

1. Start the engine, warm it up for 2~3 minutes, and then stop the engine.
2. Place an oil pan under the engine to collect the used oil.
3. Remove the engine oil drain bolt① to drain the oil from the crankcase.
4. Remove the bolt 2 and filter cover 3, remove the filter, wash it and install again.

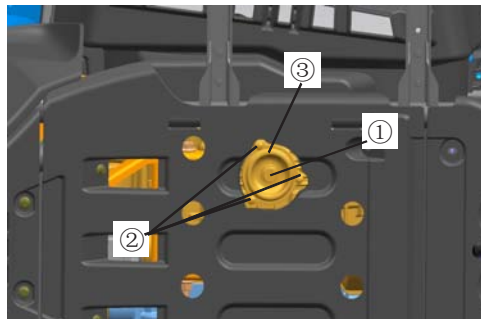

Oil filter replacement

1. Use wrench to unscrew 3 pcs of bolts ① as right picture shows. Then remove cover ② of oil filter and remove oil filter ③.

2. Install new oil filter on it.

Attention: Confirm if O-ring ④ is good and then install it into groove of crankcase correctively.

3. Install new oil filter ③, and use wrench to tighten 3 pcs of bolts ① on cover ② by specified torque.

⚠ NOTE : Tightening torque of bolt ①: 10 N • m

4. Use new washer to assemble and tighten oil drain bolt as specified torque.

⚠ NOTE : Tightening torque of drain bolt: 30 N • m

5. Add the specified amount of recommended engine oil, and then insert the engine oil dipstick and tighten it.

⚠ NOTE :

In case of engine overhaul, oil should be added : 3.0 L ;

Without oil filter cartridge replacement, oil should be added: 2.8 L

With oil filter cartridge replacement, oil should be added: 2.9L

6. Start the engine and warm it up for several minutes. While warming up, check for oil leakage. If oil leakage is found, turn the engine off immediately and check for the cause.

7. Turn the engine off, and then check the oil level and correct it if necessary.

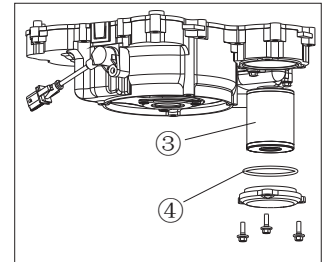
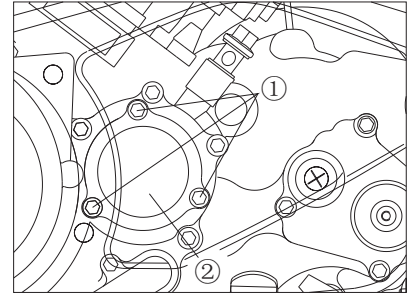

Maintenance & Lubrication

Rear gear case oil

The rear gear case must be checked for oil leakage before each ride. If any leakage is found, have your dealer check and repair the ATV.

Rear gear oil change

1. Place the machine on a level place.
2. Place a container under the rear gear case to collect the used oil.
3. Remove the filler bolt ① and the drain bolt ② as right picture shows and drain used oil.
4. Install and tighten drain bolt ② as specified torque, after adding new gear oil into rear gear case, lastly Install the filler bolt ① as specified torque.

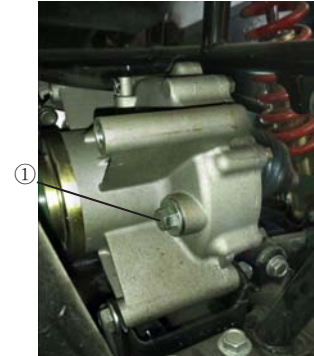

⚠ NOTE

Tightening torque of drain bolt: 23N.m

⚠ NOTE

Periodic oil change: 0.25 L

Oil capacity of rear gear case: 0.30 L



Maintenance & Lubrication

5. Check if any oil leakage. In case of leakage, please find causes and remove it.

⚠ Attention: Be sure foreign material enters the rear gear case.

Front gear case oil measurement

1. Place the machine on a level place.
2. Remove the oil filler bolt ② and check the oil level. It should be up to the brim of the hole. If the level is low, add sufficient oil to raise it to the specified level.
3. Install the oil filler bolt and tighten it to the specified torque.

⚠ NOTE

Oil filler bolt tightening torque: 23 N • m

Front gear case oil change

1. Place the machine on a level place.
2. Place a container under the front gear case to catch the oil.
3. Remove oil filler bolt and drain bolt ① at the bottom of front gear case, and drain used oil.

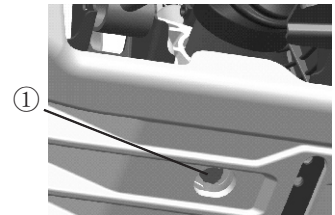
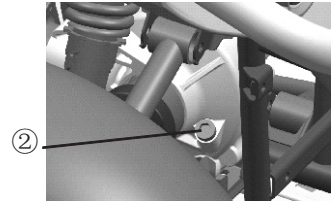

Maintenance & Lubrication

Front gear case oil change

4. Install the drain bolt and tighten it to the specified torque.

⚠ NOTE

Drain bolt tightening torque: 10 N·m

5. Fill the front gear case with oil.

⚠ NOTE

Periodic oil change: 0.28 L

Oil capacity: 0.33 L

6. Install the filler bolt ② as page 102 shows and tighten it to the specified torque.

7. Check for oil leakage. If oil leakage is found, check for the cause.

⚠ NOTE

Be sure no foreign material enters the front gear case.

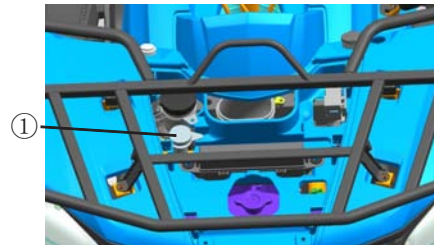

Maintenance & Lubrication

Cooling system

1. Place the ATV on a level surface.
2. Check the coolant level in the coolant reservoir when the engine is cold as the coolant level will vary with engine temperature.

⚠ NOTE

The coolant should be between the upper and lower limit marks.

Cooling system

3. If the coolant is at or below the lower limit mark, remove the reservoir cap①, add coolant to the upper limit mark, install the reservoir cap, and then install the panel.

⚠ NOTE

Lowest capacity of coolant reservoir: 0.23 L

⚠ CAUTION

Hard water or salt water is harmful to the engine. You may use soft water if you can not get distilled water.

⚠ Attention

If water is added, have your dealer check the antifreeze content of the coolant as soon as possible. The radiator fan operation is completely automatic. It is switched on or off according to the coolant temperature in the radiator

Maintenance & Lubrication

Changing the coolant

1. Place the ATV on a level ground.
2. Place a container under the engine, and then remove (engine Left cover①、smaller engine left cover②) the coolant drain bolt③.
3. Remove the radiator cap⑤.
4. Remove the coolant reservoir cap④.

⚠ DANGER

After stop the engine, you cannot remove cap of radiator immediately. Wait for a while to cool down the coolant and then remove radiator cap. Otherwise hot coolant will goes out to hurt people nearby.

5. Disconnect the hose on the coolant reservoir side, and then drain the coolant from the coolant reservoir.
6. After draining the coolant, thoroughly flush the cooling system with clean tap water.
7. Replace the coolant drain bolt washer if it is damaged, and then tighten the coolant drain bolt to the specified torque.

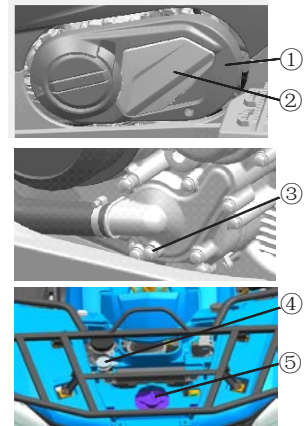

Maintenance & Lubrication

⚠ NOTE

Coolant drain bolt tightening torque: 10 N • m

8. Install the coolant reservoir hose.

9. Fill the recommended coolant into the radiator until it is full.

When filling coolant, at the same time to loosen tapping screw as right picture ③ shows in order to drain potential air bubbles inside the coolant hose, until coolant goes out, then tighten the screw.

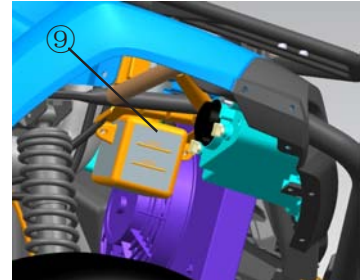

⚠ NOTE

Recommended antifreeze:

High quality ethylene glycol antifreeze containing corrosion inhibitors for aluminum engines. Antifreeze and water mixing ratio:1:1

Coolant capacity: 2.0 L.

Coolant change : 1.9 L.

Coolant reservoir capacity : 0.23~0.41 L

Maintenance & Lubrication

CAUTION

Hard water or salt water is harmful to the engine.
Please use CFMOTO recommended coolant.

10. Install the radiator cap.
11. Start the engine and let it idle for several minutes. Stop the engine, and then check the coolant level in the radiator. If it is low, add more coolant until it reaches the top of the radiator.
12. Fill the coolant reservoir with coolant up to the upper limit.
13. Install the coolant reservoir cap and check for coolant leakage.

NOTE

If any leakage is found, have your dealer check the cooling system.

14. Install the panels and the front rack.

Maintenance & Lubrication

● Axle dust boots

Check the protective boots for holes or wears.
If any damage is found, have them replaced by your dealer.

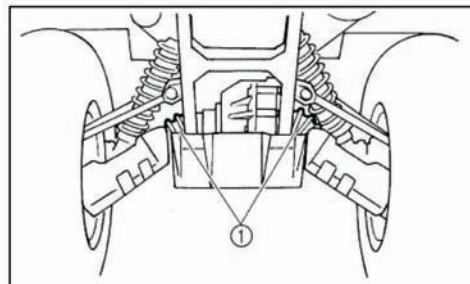
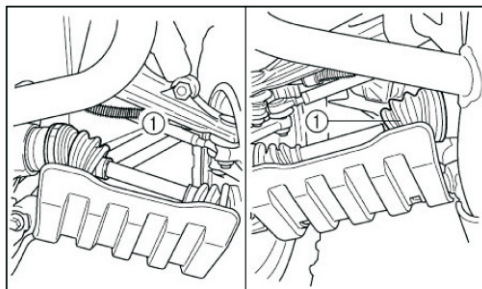

● Spark plug inspection

Removal

1. Remove the panel.
2. Remove the spark plug cap①.
3. Use the spark plug wrench in the tool kit to remove the spark plug as shown.

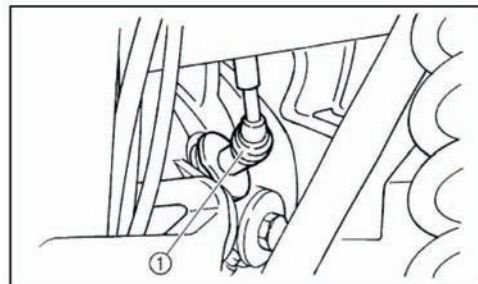

Maintenance & Lubrication

Inspection

The spark plug is an important engine component and is easy to inspect. The condition of the spark plug can indicate the condition of the engine. The ideal color on the white insulator around the center electrode is a medium-to-light tan color for a ATV that is being ridden normally. Do not attempt to diagnose such problems yourself. Instead, take the ATV to your dealer. You should periodically remove and inspect the spark plug because heat and deposits will cause the spark plug to slowly break down and erode. If electrode erosion becomes excessive, or if carbon and other deposits are excessive, you should replace the spark plug with the specified plug.

⚠ NOTE : Specified spark plug: DCPR8E (NGK)

Installation

Measure the electrode gap with a wire thickness gauge and, if necessary, adjust the gap to specifications.

- ⚠ NOTE** :
1. Spark plug gap: 0.8~0.9 mm
 2. Clean the gasket surface. Wipe off any grime from the threads.
 3. Install spark plug and tighten to specified torque.

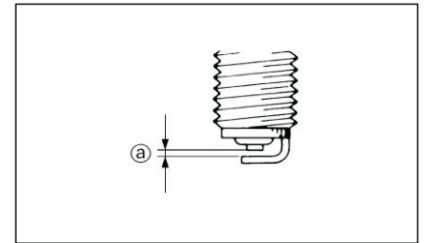
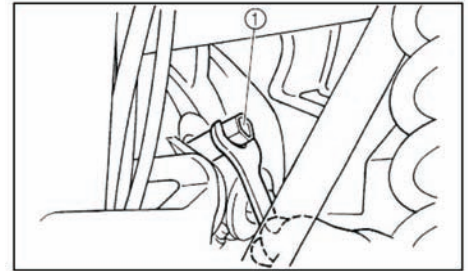

Maintenance & Lubrication

⚠ NOTE : Tightening torque of spark plug: 20N · m

If a torque wrench is not available when you are installing a spark plug, a good estimate of the correct torque is 1/4 to 1/2 turn past finger tight. Have the spark plug tightened to the specified torque as soon as possible.

4. Install the spark plug cap.
5. Install the panel.

● Air filter element cleaning

There is a check hose ① at the bottom of the air filter case. If dust or water collects in this hose, empty the hose and clean the air filter element and air filter case. If there's a lot for water, please contact your local dealer to check if any water inside crankcase.

1. Remove seat and disassemble cover of air filter.
2. Remove spring ① and remove upper cover of air filter ②.
3. Remove bolt of pipe clamp③.
4. Remove air filter element ④.
5. Remove polyurethane foam of filter element,

Wash the air filter element gently but thoroughly in solvent. Squeeze the excess solvent out of the air filter element and let it dry.

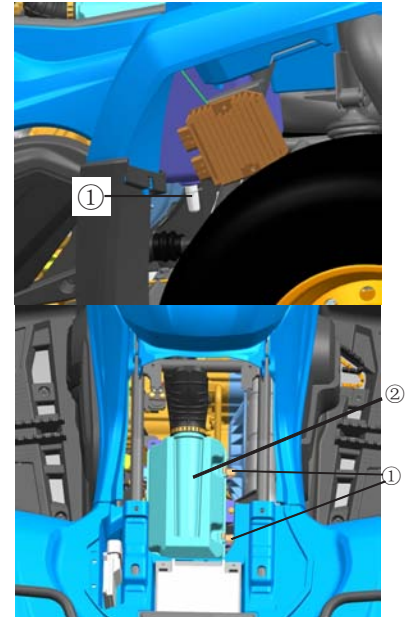

Maintenance & Lubrication

6. Softly clean dust on filter element.
7. If necessary, use new filter element to replace.

⚠ CAUTION

Don't use liquid to wash paper filter element.

8. Inspect the air filter element and replace it if damaged.
9. Install air filter element and connect to hose.
10. Install the air filter case cover and be sure to seal ring installed well.

⚠ NOTE

The air filter element should be cleaned every 50 hours, It should be cleaned and lubricate more often if the machine is operated in extremely dusty areas. Each time air filter element maintenance is performed, check the air inlet to the air filter box for obstructions. Check the air filter element rubber joint to the throttle body and manifold fittings for an airtight seal. Tighten all fittings securely to avoid the possibility of unfiltered air entering the engine.

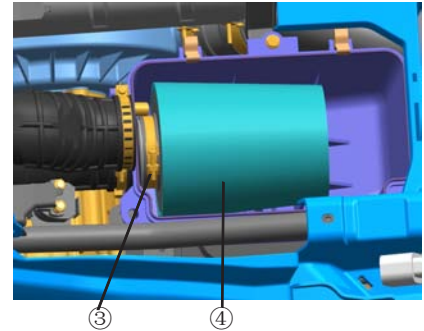

Maintenance & Lubrication

⚠ DANGER

Do not start engine without air filter element. Not filtered air will enter into the engine and cause engine wearing and damage. In addition, driving without air filter will also decrease performance and engine overheating.

Clean spark arrester:

Clean spark arrester while muffler and exhaust are in normal temperature.

1. Remove bolts ①.
2. Remove spark arrester ② from muffler;
3. Tap the tailpipe lightly, and then use a wire brush to remove any carbon deposits ③ from the spark arrester portion of the tailpipe.
4. Insert the tailpipe into the muffler and align the bolt holes;
5. Install and tighten the bolts ①.

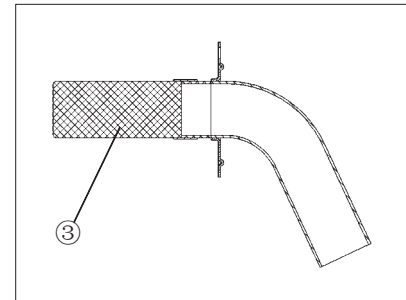
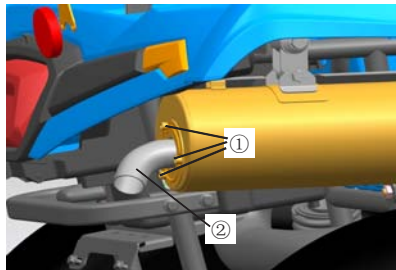

Maintenance & Lubrication

⚠ DANGER

When cleaning the spark arrester: Always let the exhaust system cool prior to touching exhaust components. Do not start the engine when cleaning the exhaust system.

CVT air-outlet hose cleaning

If dust or water collects in the V-belt cooling duct check hose, remove the hose ① and clean it.

CVT cover drain bolt

After riding in water deep enough to allow it to enter the V-belt case, remove this bolt ② to drain the water from the case.

⚠ WARNING

If water drains from the V-belt case after removing the bolt, have your dealer inspect the ATV as the water may affect other engine parts.

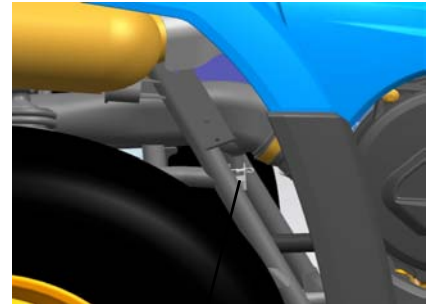

①

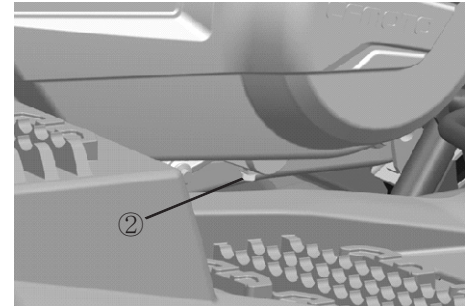

②

Maintenance & Lubrication

Throttle body adjustment

The throttle body is a vital part of the engine and requires very sophisticated adjustment. Most adjusting should be left to your dealer who has the professional knowledge and experience to do so. However, the idling speed may be performed by the owner as a part of the usual maintenance routine. The throttle body was set at the factory after many tests. If the settings are disturbed by someone without sufficient technical knowledge, poor engine performance and damage may result. Check idle for stability and contact your dealer for service if necessary.

Engine idel adjustment:

⚠ WARNING

this vehicle is equipment with EFI system, and no need to adjust idle, or performance will be affected. Contact your dealer in case abnormal idle.

⚠ NOTE

Engine idle: 1,500 ± 100r/min (Heated engine)

• Engine airinlet/outlet valve clearance adjustment

The correct valve clearance changes with use, resulting in improper fuel/air supply or engine noise. To prevent this, the valve clearance must be adjusted regularly. This adjustment however, should be left to a professional service technician.

Maintenance & Lubrication

⚠ NOTE

Adjust the engine idling speed before Adjusting the throttle lever free play on Page 114.

1. Loosen nut ①.
2. Turn adjustment nut ② to lever travel:
 ⓐ : 3~5 mm.
3. Fasten nut ①.

● Front brake pad check

Inspect the brake pads and brake disks for damage and wear. If the thickness "a" is less than 1.5mm or "b" is less than 3.0mm, then have your dealer replace them..

⚠ NOTE

Front wheels need to be removed to check brake pads ①.

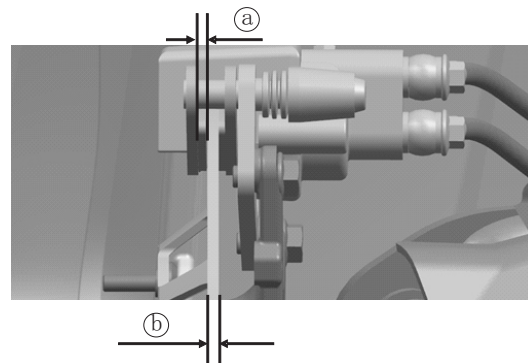
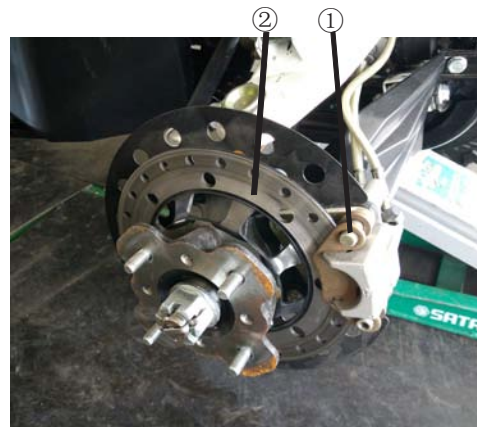

Maintenance & Lubrication

● Rear brake pad inspection

Inspect the brake pads and brake disks for damage and wear. If the thickness "a" is less than 1.5mm or "b" is less than 6.5mm, then have your dealer replace them.

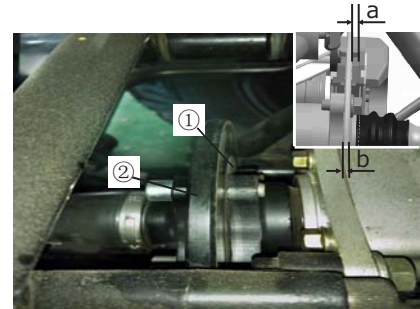

● Inspect brake fluid level

Insufficient brake fluid may let air enter the brake system, possibly causing the brakes to become ineffective.

Before riding, check that the brake fluid is above the lower level and replenish when necessary. The front brake fluid master cylinder reservoir is located the right of the handlebar. The rear brake fluid master cylinder reservoir is near the rear brake pedal.

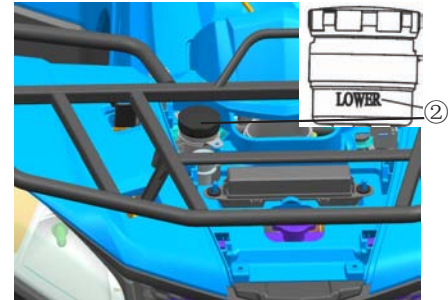
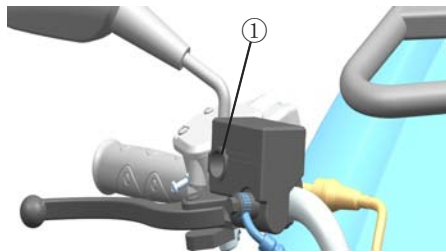

Maintenance & Lubrication

● Inspect brake fluid level

Observe these precautions:

1. When checking the fluid level, make sure the top of the master cylinder reservoir is level by turning the handlebars.
2. Use only the designated quality brake fluid. Otherwise, the rubber seals may deteriorate, causing leakage and poor brake performance.

⚠ NOTE

Recommended brake fluid: DOT3 or DOT 4.

3. Refill with the same type of brake fluid. Mixing fluids may result in a harmful chemical reaction and lead to poor brake performance.
4. Be careful that water does not enter the master cylinder reservoir when refilling. Water will significantly lower the boiling point of the fluid and may result in vapor lock.
5. Brake fluid may deteriorate painted surfaces or plastic parts. Always clean up spilled fluid immediately.
6. Have your dealer check the cause if the brake fluid level goes down.

Maintenance & Lubrication

● Brake fluid change

Complete fluid replacement should be done only by trained service personnel. Have your dealer replace the following components during periodic maintenance or when they are damaged or leaking.

- Replace the oil seals every two years;
- Replace the brake hoses every four years.

● Front lever free play

The front brake lever should have a free play of zero mm (zero in) at the lever end. If not, have your dealer check the brake system.

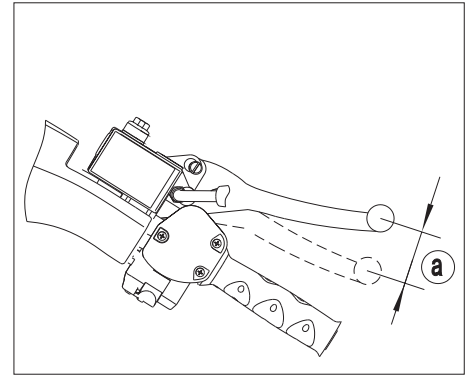

⚠ DANGER(After servicing):

- Make sure the brakes operate smoothly and that the free play is correct;
- Make sure the brakes do not drag. Make sure the brakes are not spongy.
- All air must be bled from the brake system. Replacement of brake components requires professional knowledge. These procedures should be performed by your dealer.

Maintenance & Lubrication

• Rear brake pedal hight adjustment

⚠ NOTE

Adjust the rear brake before inspecting the rear brake pads.

The top of the brake pedal should be positioned 70~80mm above the top of the footrest. If not, ask your dealer to adjust it.

⚠ DANGER

After servicing:

- Make sure the brakes operate smoothly and that the free play is correct.
- Make sure the brakes do not drag ;
- All air must be bled from the brake system.

Replacement of brake components requires professional knowledge. These procedures should be performed by your dealer.

• Rear brake light switch

The rear brake light switch, which is activated by the brake pedal and brake levers, is properly adjusted when the brake light comes on just before braking takes effect.



Maintenance & Lubrication

• Rear brake light switch

Check switch assembly or cable is properly fixed in case light failure.

Cable inspection and lubrication

⚠ DANGER

Inspect cables frequently. Replace damaged cables. Lubricate the inner cables and the cable ends. If the cables do not operate smoothly, ask your dealer to replace them.

⚠ NOTE

Recommended lubricant: SAE 10W30

Rear knuckle upper and lower pivot Lubrication:

Lubricate the upper and lower shaft of the rear axle

Remove the rear wheel 1, Add oil into the oil cup 2 between the upper and lower axle with spray gun.

⚠ NOTE

Recommend lubrication: lithium base grease

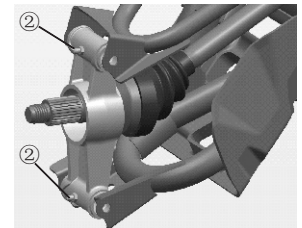

Maintenance & Lubrication

⚠ NOTE

Recommended lubricant: Lithium-soap-based grease

Wheel removal

1. Loosen the wheel nuts.
2. Elevate the ATV and place a suitable stand under the frame.
3. Remove the nuts from the wheel.
4. Remove the wheel.

Wheel installation:

1. Install the wheel and the nuts.

⚠ NOTE

- Tapered nuts are used for both the front and rear wheels. Install the nut with its tapered side towards the wheel
- The arrow mark on the tire must point toward the rotating direction of the wheel.



Maintenance & Lubrication

2. Lower the ATV so that the wheel is on the ground.
3. Tighten the wheel nuts to the specified torque.

⚠ NOTE

Wheel nut torque: Front: 55 N·m; Rear: 55 N·m .



● **Battery**

This machine is equipped with service-needless battery. Therefore it is not necessary to check the electrolyte or add distilled water in the battery. If the battery seems to have discharged, consult your dealer.

⚠ NOTE

Battery specification: 12V 30Ah

Maintenance & Lubrication

⚠ WARNING

Do not try to remove the sealing caps of the battery cells. You may damage the battery.

⚠ DANGER

Avoid contact with skin, eyes or clothing. Always shield eyes when working near batteries. Keep out of reach of children.

Antidote:

EXTERNAL: Flush with water. INTERNAL: Drink large quantities of water or milk. Follow with milk of magnesia, beaten egg or vegetable oil. Get prompt medical attention.

EYES: Flush with water for 15 minutes and get prompt medical attention. Keep batteries away from sparks, flames, cigarettes or other sources of ignition. Ventilate when charging or using in a closed space.

Battery maintenance:

1. When the machine is not used for a month or longer, remove the battery and store it in a cool, dark place. Completely recharge the battery before reinstallation.
2. A special battery charger (constant voltage/ampere or constant voltage) is required for recharging battery. Use a conventional battery charger may shorten the battery life.
3. Always make sure the connections are correct when putting the battery back in the machine.

Maintenance & Lubrication

● Fuse replacement

1. The main fuse case and the fuse box are located under front top cover
2. If a fuse is blown, turn off the main switch and install a new fuse of the specified amperage.
- Then turn on the switches. If the fuse immediately blows again, consult your dealer.

Danger:

Always use a fuse of the specified rating.
Never use a material in place of the proper fuse.

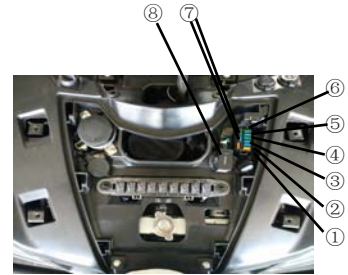

- | | | |
|-------------------------------|---------------------------|---------------------------|
| ①. Headlight fuse 15A | ⑤. null | ⑥. Oxygen Sensor fuse(5A) |
| ②. Fan fuse 15A | ⑦. Spare fuse(15A/10A/5A) | |
| ③. Start relay fuse 15A | ⑧. Flash | |
| ④. Signal, Fuel pump fuse 10A | | |

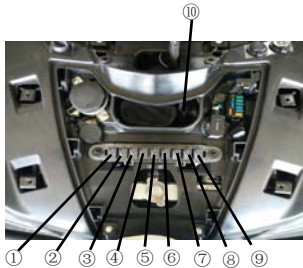

- | | |
|--------------------|------------------------|
| ①. Auxiliary Relay | ⑥. Fan Relay |
| ②. Fuel pump Relay | ⑦. lower beam Relay |
| ③. Brake Relay | ⑧. higher beam Relay |
| ④. 4x4 LOCK Relay | ⑨. Null |
| ⑤. 4x2 Relay | ⑩. Winch control Relay |

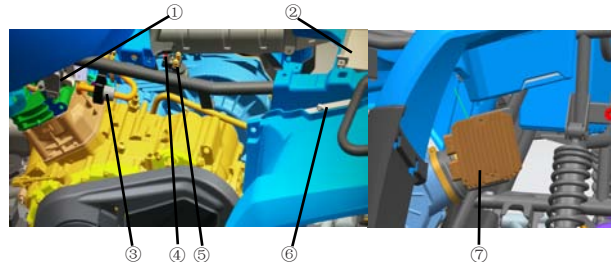

- | | | |
|-------------------------------|----------------|------------------------|
| ①. High-Tension Ignition coil | ④. Fuse(20A) | ⑦. Regulator/Rectifier |
| ②. Battery | ⑤. Start Relay | |
| ③. Idle Valve | ⑥. ECU | |

Maintenance & Lubrication

⚠ WARNING

To prevent accidental short-circuit, turn off the main switch when checking or replacing

Headlight adjustment/ Lamp replacement:

Remove the two screws ② and plastic clamp ③, remove the headlight panel ①, you can adjust, remove, install and replace it.

Beam adjustment:

Remove the three screws ⑤

Switch the two adjust screws ④, adjust the high or low direction of the low/high beam ⑦ vertically and horizontally.

Lamp replacement ⑥:

1. Remove the connectors in the lamp, hold the lamp holder and turn it to 60 degree anticlockwise.

2. Reverse the above steps to install the new lamp.

Lamp Size: HS1 35W×2

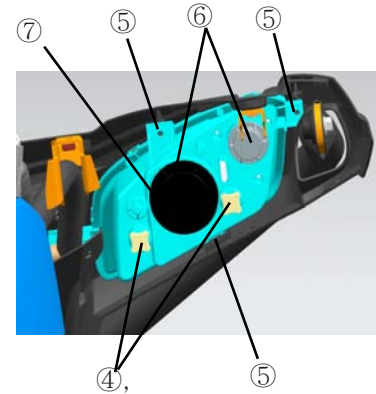
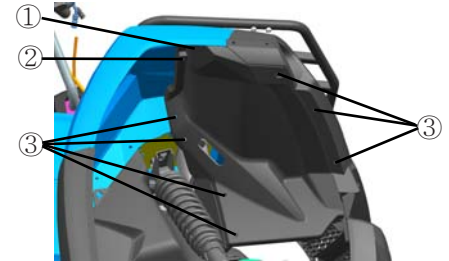

⚠WARNING

Touch the lamp only after it has been cooled down.

Front turning light ① and daytime running lamp ② , ③ Front position light is the LED whole structure, which can't be fixed if there is any damage, only can be replaced.

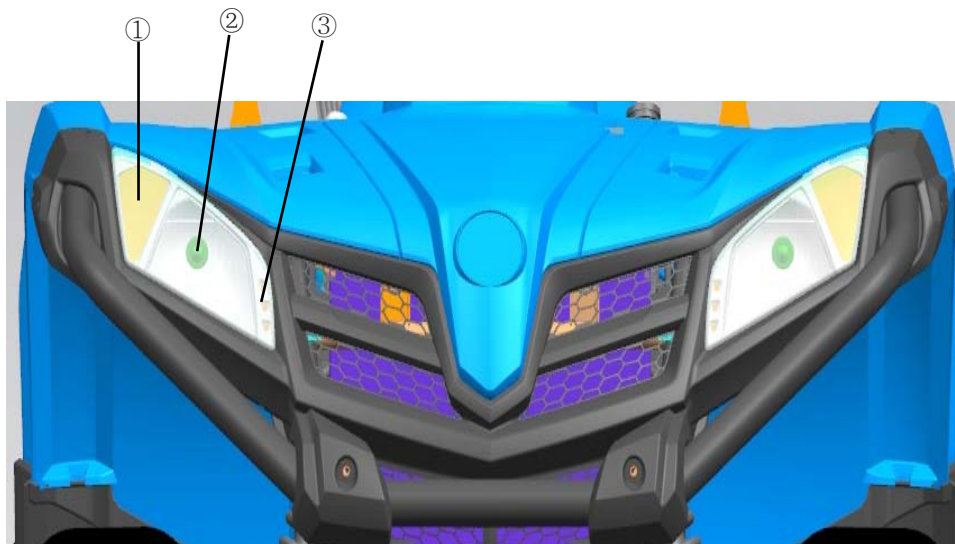

Maintenance & Lubrication

● Headlight beam adjustment

⚠ WARNING

It is advisable to have your dealer make this adjustment. Turn the adjusting screws ① can raise or lower the beam.

Taillight Replacement:

The taillight is is the Bulb whole structure, which can't be fixed if there is any damage, only can be replaced.

1. Remove the two screws ① to remove the taillight and tail light cover ②.
2. Remove the two screws ③ to remove the defected or damaged taillight.
3. Replace the new taillight reverse the step ② and ③.

License plate lamp

If the License plate lamp is damaged, pull out the lamp holder from the rear of the License plate lamp to replace it.

Specification: 12V 5W W5W

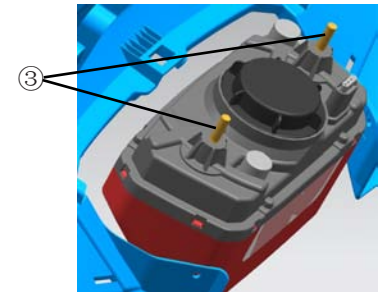
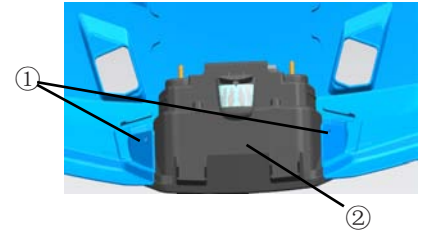

Maintenance & Lubrication

• Front and rear suspension adjustment

The spring preload can be adjusted to suit the rider's weight and riding conditions.

Standard shock absorbers

⚠ NOTE

When adjusting the rear shock absorbers, the rear wheels need to be removed. adjust the spring preload as follows.

To increase the spring preload, turn the adjusting ring in Direction (a) .

To decrease the spring preload, turn the adjusting ring in Direction (b) .

⚠ NOTE

A special wrench can be obtained at a dealer to make this adjustment.

Standard position: B

A- Minimum (soft)

E- Maximum (hard)

⚠ DANGER

Always adjust the shock absorbers on the left and right side to the same setting.



Maintenance & Lubrication

Vehicle immersion

WARNING

If your vehicle becomes immersed, major engine damage can result if the machine is not thoroughly inspected. Take the vehicle to your dealer before starting the engine. For example, if engine is not properly handled after immersion, starting will damage the engine.

Clean & Storage

Cleaning the ATV

Keeping your ATV clean will not only improve its appearance but it can also extend the life of various components. With a few precautions, your ATV can be cleaned much like an automobile.

Washing the ATV

The best and safest way to clean your ATV is with a garden hose and a pail of mild soap and water. Use a professional type washing mitt, cleaning the upper body first and the lower parts last. Rinse with water frequently and dry with a chamois to prevent water spots.

NOTE

If warning and safety labels are damaged, contact your dealer for replacement.

We do not recommend the use of a high pressure type car wash system for washing your ATV. If a high pressure system is used, exercise extreme care to avoid water damage to the wheel bearings, transmission seals, body panels, brakes, warning labels, air filter intake system and electric system, etc. Water is not allowed to enter into air filter.

NOTE

Grease all zerk fittings immediately after washing, and allow the vehicle to run for a while to evaporate any water that may have entered the engine or exhaust system.

Clean & Storage

Waxing the ATV

Your ATV can be waxed with any non–abrasive automotive paste wax. Avoid the use of harsh cleaners since they can scratch the body finish.

CAUTION

Certain products, including insect repellants and chemicals, will damage plastic surfaces. Use caution when using these products near plastic surfaces.

CAUTION

Starting the engine during the storage period will disturb the protective film created by fogging and damage could occur. Never start the engine during the storage period.

Clean the Exterior

Make necessary repairs and then clean the ATV thoroughly with mild soap and warm water to remove all dirt and grime. Do not use harsh detergents or high pressure washers. Some detergents deteriorate rubber parts. Use dish soap type cleaners only. High pressure washers may force water past seals.

Clean & Storage

Oil and Filter

Warm the engine, then stop the engine and change the oil and filter.

⚠ CAUTION

When drain out fuel in fuel pipe and air pipe, if dashboard says only one grid of fuel left, remove fuel pump connector to drain out fuel in fuel tank, or else, it may damage fuel pump.

Air Filter/ Air Box

Inspect and clean or replace air filter. Clean the air box and drain the sediment tube.

Fluid Levels

Inspect the following levels and change if necessary: front gear case, rear gear case, engine oil, brake fluid (change every two years or as required if fluid looks dark or contaminated) , coolant.

Clean & Storage

Fog the Engine

Remove spark plug and add 15~20ml SAE 15W~40/SG engine oil. To access the plug hole, use a section of clean hose and a small plastic squeeze bottle filled with the pre-measured amount of oil.

⚠ CAUTION

Do this carefully! If you miss the plug hole, oil will drain from the spark plug cavity, and appear to be an oil leak.

Remove plug cap and turn crankshaft to make engine run slowly. Oil will be forced in and around the piston, piston rings and coating the cylinder with a protective film of fresh oil.

If you choose not to use the above way, perform the following procedure:

1. Support the front end of the vehicle so the engine is level or tilted slightly rearward.
2. Remove the spark plug, rotate the piston to BDC and pour approximately 15~20ml oil into cylinder.
3. Remove plug cap and turn crankshaft to make engine rotate slowly.
4. Turn engine several times to ensure the coverage of piston rings and cylinder walls.
5. Treat the fuel system with Carbon Clean.
6. If fuel system Carbon Clean is not used, fuel tank, fuel pipe and throttle body should be completely drained of gasoline. To eliminate any fuel remaining in the fuel pipe.

Clean & Storage

Lubricate

Inspect all cables and lubricate with Cable Lubricant. Follow lubrication guidelines in the maintenance section of the service manual to completely grease and lubricate the entire vehicle with All Season Grease.

Battery Storage

Remove battery from the vehicle and ensure that it is fully charged before placing it in storage.

Engine Anti-Freeze

Test engine coolant strength and change if necessary. Coolant should be replaced every two years.

Storage Area/Covers

set the tires to specified air pressure and support the ATV with tires 30 ~ 40mm off the ground. Be sure the storage area is well ventilated and cover the machine with a ATV cover.

Clean & Storage

⚠ NOTE

Do not use plastic or coated materials. They do not allow enough ventilation to prevent condensation, and may promote corrosion and oxidation.

Transporting the ATV

ATV can not be transported with stand up position, follow these procedures when transporting the vehicle:

1. Turn off the engine and remove the key to prevent loss during transporting.
2. Place the gear into any position except Park position, block front and rear wheels to prevent ATV run.
3. Never transport ATV with gear in Park position, or else engine will be damaged.
4. Fix both the front and rear frame of ATV at the same time, prevent ATV slide or move during transportation.
5. Be sure the fuel cap, oil cap and seat are installed correctly.

Troubleshooting

Drive belt and cover problems

Possible Cause	Solution
Driving the ATV onto a pickup or tall trailer in high range.	Shift transmission to low range during loading of the ATV to prevent belt burning.
Starting out going up a steep incline.	When starting out on an incline, use low range or dismount the ATV (after first applying the park brake) and perform the K-turn as described on page 81.
Driving at low RPM or low ground speed(at approximately 5~10 km/h).	Drive at a higher speed or use low range more frequently. The use of low range is highly recommended for cooler CVT operating temperatures and longer component life.
Insufficient warm-up of ATVs exposed to low ambient temperatures.	Warm the engine before driving, the belt will become more flexible and prevent belt burning.
Slow and easy CVT engagement.	Use the throttle quickly and effectively for efficient engagement.
Towing/pushing at lowRPM/low ground speed.	Use low range only.
Utility use/plowing snow, dirt, etc.	Use low range only.

Troubleshooting

Possible Cause	Solution
Stuck in mud or snow.	Shift the transmission to low range, and carefully use fast, aggressive throttle application to engage CVT. WARNING: Excessive throttle may cause loss of control and vehicle overturn.
Climbing over large objects from a stopped position.	Shift the transmission to low range, and carefully use fast, brief, aggressive throttle application to engage CVT. Excessive throttle may cause loss of control and vehicle overturn.
Belt slippage from water or snow ingestion into the CVT system.	Remove the CVT cover, drain the water from CVT.
CVT malfunction.	Contact your dealer for inspection of CVT components.

Troubleshooting

Engine doesn't turn over

Possible Cause	Solution
Poor engine performance.	Check for fouled plugs or foreign material in gas tank, fuel lines, or throttle. Contact your dealer for service.
Tripped circuit breaker	Reset the breaker
Low battery voltage	Recharge battery to 12.5 VDC
Loose battery connections	Check all connections and tighten
Loose solenoid connections	Check all connections and tighten

Engine Pings or Knocks

Possible Cause	Solution
Poor quality or low octane fuel	Replace with recommended fuel
Incorrect ignition timing	See your dealer
correct spark plug gap or heat range	Set gap to specs or replace plugs

Troubleshooting

Engine Stops or loses power

Possible Cause	Solution
Overheated engine	Clean radiator screen and core if equipped Clean engine exterior See your dealer

Troubleshooting

Engine Turns Over, Fails to Start

Possible Cause	Solution
Out of Fuel	Refuel
Clogged fuel valve or filter	Inspect and clean or replace
Water is present in fuel	Drain the fuel system and refuel
Fuel valve is out of use	Replace
Old or non-recommended fuel	Replace with new fuel
Fouled or defective spark plug(s)	Inspect plug(s), replace if necessary
No spark to spark plug	Inspect plug(s) , verify stop switch is on
Crankcase filled with water or fuel	Immediately see your dealer
Overuse of choke	Inspect, clean and/or replace spark plugs
Clogged fuel injector	Clean or replace new fuel injector
Low battery voltage	Recharge battery to 12.5 VDC
Mechanical failure	See your dealer

Troubleshooting Engine Backfires

Possible Cause	Solution
Weak spark from spark plugs	Inspect, clean and/or replace spark plugs
Incorrect spark plug gap or heat range	Set gap to specs or replace plugs
Old or non-recommended fuel	Replace with new fuel
Incorrectly installed spark plug wires	See your dealer
Incorrect ignition timing	See your dealer
Mechanical failure	See your dealer

Engine Runs Irregularly, Stalls or Misfires

Possible Cause	Solution
Fouled or defective spark plugs	Inspect, clean and/or replace spark plugs
Worn or defective spark plug wires	See your dealer
Incorrect spark plug gap or heat range	Set gap to specs or replace plugs
Loose ignition connections	Check all connections and tighten
Water present in fuel	Replace with new fuel
Low battery voltage	Recharge battery to 12.5 VDC

Troubleshooting

Engine Runs Irregularly, Stalls or Misfires

Possible Cause	Solution
Kinked or plugged fuel vent line	Inspect and replace
Incorrect fuel	Replace with recommended fuel
Clogged air filter	Inspect and clean or replace
Reverse speed limiter malfunction	See your dealer
Electronic throttle control malfunction	See your dealer
Other mechanical failure	See your dealer
Possible Lean or Rich Fuel Mixture Cause	Solution
Low or contaminated fuel	Add or change fuel, clean the fuel system
Low octane fuel	Replace with recommended fuel
Clogged fuel filter	Replace filter
Incorrect jetting	See your dealer
Overuse of choke	Inspect, clean and/or replace spark plugs
Fuel is very high octane	Replace with lower octane fuel

Troubleshooting

Engine Stops or Loses Power

Possible Cause	Solution
Out of fuel	refuel
Kinked or plugged fuel vent line	Inspect and replace
Water present in fuel	Replace with new fuel
Overuse of choke	Inspect, clean and/or replace spark plugs
Fouled or defective spark plugs	Inspect, clean and/or replace spark plugs
Worn or defective spark plug wires	See your dealer
Incorrect spark plug gap or heat range	Set gap to specs or replace plugs
Loose ignition connections	Check all connections and tighten
Low battery voltage	Recharge battery to 12.5 VDC
Clogged air filter	Inspect and clean or replace
Reverse speed limiter malfunction	See your dealer
Electronic throttle control malfunction	See your dealer
Other mechanical failure	See your dealer

Troubleshooting

PCODE LIST

PCODE uses 4 digit flashing:

For Example: “0650”

“0” flashes 10 times.

“6” flashes 6 times.

“5” flashes 5 times.

“0” flashes 10 times.

Item No	Trouble code	Trouble Description
1	P0030	O2S HEATING CNTRL CIRCUIT OPEN
2	P0031	O2S HEATING CNTRL CIRCUIT SHORT TO GND
3	P0032	O2S HEATING CNTRL CIRCUIT SHORT TO BATT
4	P0107	Manifold Abs.Pressure or Bar.Pressure Low Input
5	P0108	Manifold Abs.Pressure or Bar.Pressure High Input
6	P0112	Intake Air Temp.Circ. Low Input
7	P0123	Intake Air Temp.Circ. High Input
8	P0117	Engine Coolant Temp.Circ. Low Input

Troubleshooting

Item No	Trouble code	Trouble Description
9	P0118	Engine Coolant Temp.Circ. High Input
10	P0122	Throttle/Pedal Pos.Sensor A Circ.Low Input
11	P0123	Throttle/Pedal Pos.Sensor A Circ. High Input
12	P0130	O2 Sensor Circ.,Bank1-Sensor1 Malfunction
13	P0131	O2 Sensor Circ.,Bank1-Sensor1 low Voltage
14	P0132	O2 Sensor Circ. ,Bank1-Sensor1 High Voltage
15	P0134	O2 Sensor Circ. ,Bank1-Sensor1 No Activity Detected
16	P0201	Cylinder 1- Injector Circuit
17	P0261	Cylinder 1- Injector Circuit Low
18	P0262	Cylinder 1- Injector Circuit High
19	P0321	Ign./Distributor Eng.Speed Inp.Circ. Range/Performance
20	P0322	Ign./Distributor Eng.Speed Inp.Circ.No Signal
21	P0501	Vehicle Speed Sensor Range/Performance
22	P0560	System Voltage Malfunction
23	P0562	System Voltage Low Voltage

Troubleshooting

Item No	Trouble code	Trouble Description
24	P0650	System Voltage High Voltage
25	P0563	Fuel Pump“A” Control Circuit/Open
26	P0628	Fuel Pump“A” Control Circuit Low
27	P0629	Fuel Pump“A” Control Circuit High
28	P0650	Malfunction Indicator Lamp Control Circ.
29	P1105	Idle Speed Actuator Circuit High
30	P1117	Idle Speed Actuator Circuit Low
31	P1118	Idle Speed Actuator Circuit Open

Troubleshooting

Electronic Fault Diagnosis Table

Code	Diagnosis content	Suggestion
21	Main torque sensor disconnection	1.Check sensor wiring harness 2. Replace ECU
22	Main torque sensor output error(voltage is too high or low)	1. Check sensor wiring harness 2. Replace ECU
23	Vice torque sensor disconnected	1. Check sensor wiring harness 2. Replace ECU
24	Vice torque sensor output error(voltage is too high or low)	1. Check sensor wiring harness 2. Replace ECU
25	Main and vice torque difference is too large	1. Check sensor wiring harness 2. Replace ECU
26	Main torque sensor inner fault	Exchange ECU
32	Current sensor zero offset is too large	Re-insert wire of the motor
33	Motor disconnected	Exchange ECU
34	Current of ECU is over the limit	Exchange ECU
35	One side of motor has no assistance	Exchange ECU
36	Motor voltage abnormal	1. Check motor wire 2. Check motor plu

EPS indicator on the Dashboard will be on when EPS system ① is equipped to the vehicle. Normally, EPS indicator will be on ② after ignition switch is turned to ON but EPS will not work. When the engine is started, EPS indicator will be off ③ and EPS starts to function.

In case there is a failure, EPS indicator starts to flash. Do NOT switch off the machine. Check the flash times of EPS indicator. Write down the flash patterns and then refer to the Trouble Code Table for diagnosis.

Each trouble code consists of 2 digits, denoted by the times of long flash and short flash of EPS indicator.

Times of long flash represent the tens digit;

Times of short flash represent the single digit;

Duration of long flash: 2 sec.

Duration of short flash: 1 sec.

Flash interval: 1 sec.

The flash cycle will repeat after EPS indicator turns off for 3 seconds.

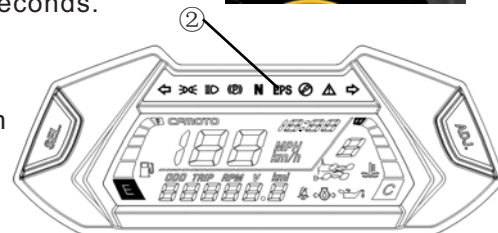
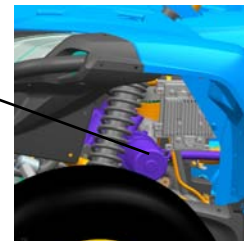

⚠ NOTE

In case of an EPS failure, do not disassemble the EPS system. Check the wiring for any loosening connection. Otherwise please contact an authorized dealer for service.

EPS fault diagnosis and solution

No.	Failure Phenomenon	Probable Reason	Troubleshooting
1	Steering without assistance	<ol style="list-style-type: none"> 1、connectors of wire is bad contact 2、The fuse blew out 3、Relay damage 4、Thecontroller、 motor or sensor is damaged 	<ol style="list-style-type: none"> 1、 Check whether wire connectors are fully inserted 2、 Replace the fuse (30A) 3、 Replace the relay 4、 Contact with suppliers and replace it
2	Power don't weighs the same for left and right	<ol style="list-style-type: none"> 1、 The median output voltage have deviation 2、 controller、 motor or sensor is damaged 	<ol style="list-style-type: none"> 1、 Disconnect motor connectors,loosen the sensor adjustment screw,adjust the sensor position to keep the voltage in $1.65V \pm 0.05V$ 2、 Contact with suppliers and replace it
3	when system is on, the steering wheel swings on both sides	<ol style="list-style-type: none"> 1、 Motor is mounted backwards 2、 controller or sensor is damaged 	<ol style="list-style-type: none"> 1、 Exchange the position of (thick line) red line and black line at the motor terminal 2、 Contact with suppliers and replace it
4	Steering becomes heavy	<ol style="list-style-type: none"> 1.Battery have power loss 2.Motor damage (power reduction) 3. air pressure of the tires (front) is insufficient. 	<ol style="list-style-type: none"> 1、 Charge 2、 Contact with suppliers and replace it 3、 Inflate tires
5	System has noise	<ol style="list-style-type: none"> 1、 Motor damage 2、 Gap of lower steering shaft assembly or mechanical steering assembly is too large 3、 Installation of lower steering shaft assembly or mechanical steering assembly is unfirm 	<ol style="list-style-type: none"> 1、 Replace 2、 Replace 3、 Check whether the installation screw is tight, reinforcement

Technical specifications

Items	Specifications	
	CF400AU	CF400AU-L
Overall Length	2100mm	2300mm
Overall Width	1100mm	1100mm
Overall Height	1150mm	1350mm
Wheel Base	1260mm	1460mm
Minimum ground clearance	250mm	250mm
Min. turning radius	4000mm	4000mm
Basic weight: (With engine oil and full fuel in tank)	345kg	360kg
Engine model and type	191Q	
Type	water-cooling/4stroke, top Single camshaft	
Bore×Stroke	91mm×61.5mm	
Displacement	400mL	
Compression ratio	10.3 :1	
Starting type	Electric start	
Lubrication type	Splashed by pressure	

Technical specifications

Items	Specifications
Engine oil: Type Engine oil volume If change oil filter If no change oil filter	SAE15W-40/SG 2.8 L 2.9 L
Rear Axle oil Type Volume Periodic oil change Capacity	SAE15W/40 SG or SAE80W/90 GL-4 0.25 L 0.30 L
Front axle oil: Type Volume Periodic oil change Capacity	SAE15W/40 SG or SAE80W/90 GL-4 0.20 L 0.20 L
Air filter	Dry-spongy filter element

Technical specifications

Items		Parameters	
Fuel type		93# octane or above unleaded gasoline	
Fuel tank capacity		15 L	
Fuel reverse amount		4.0 L	
Throttle type:		0GR0-173000	
Spark plug:			
Type		DCPR8E (NGK)	
Spark plug gap		0.8~0.9 mm	
Transmission	Transmission		(CVT) + Gear shift
	Gear shift/order		Manually/L-H-N-R-P
	CVT ratio		0.67~3.02
	Gear ratio	Low Gear	38/15=2.533
		High Gear	27/20=1.350
Reverse		29/14=2.071	
Chassis			
Frame	Steel tube		
Caster angle	3 °		
Kingpin offset	27.97mm		

Technical specifications

Items	Parameters
Tire: Type Size Front tire Rear tire	Tubeless 24x8.0-12 or At25x8.0-12 24x10.0-12 or At25x10.0-12
Tire pressure: Front tire Rear tire	56kPa or 45kPa 42kPa or 45kPa
Brake system: Unite brake Type Operation Front brake Type Operation Rear brake Type Operation	Front axes: Double-disc Rear axes: Single-disc Operated by right foot Double-disc Operated by right hand Single-disc Operated by left hand
Suspension: Front suspension Rear suspension	Double A-arm and independent Double A-arm and independent

Technical specifications

Items	Parameters
Shock absorber: Front shock absorber Rear shock absorber	Coil spring/Oil damper Coil spring/Oil damper
Wheel travel: Front wheel travel Rear wheel travel	180 mm 180 mm
Electric system Ignition Flywheel storage battery	ECU A.C magneto 12V 30A
light system Headlight type	HS1 35W×2
daytime running lamp	12V 35W×2
Front Turn light	12V W16W 16W×2
Front position light	12V 3LED/1.5W×2
Rear Turn light	12V E10W 10W×2
Tail light/Brake light	12V 21/5W×1
Registration board light	12V 5W W5W
Dashboard indicator light	LED

Wiring Diagram

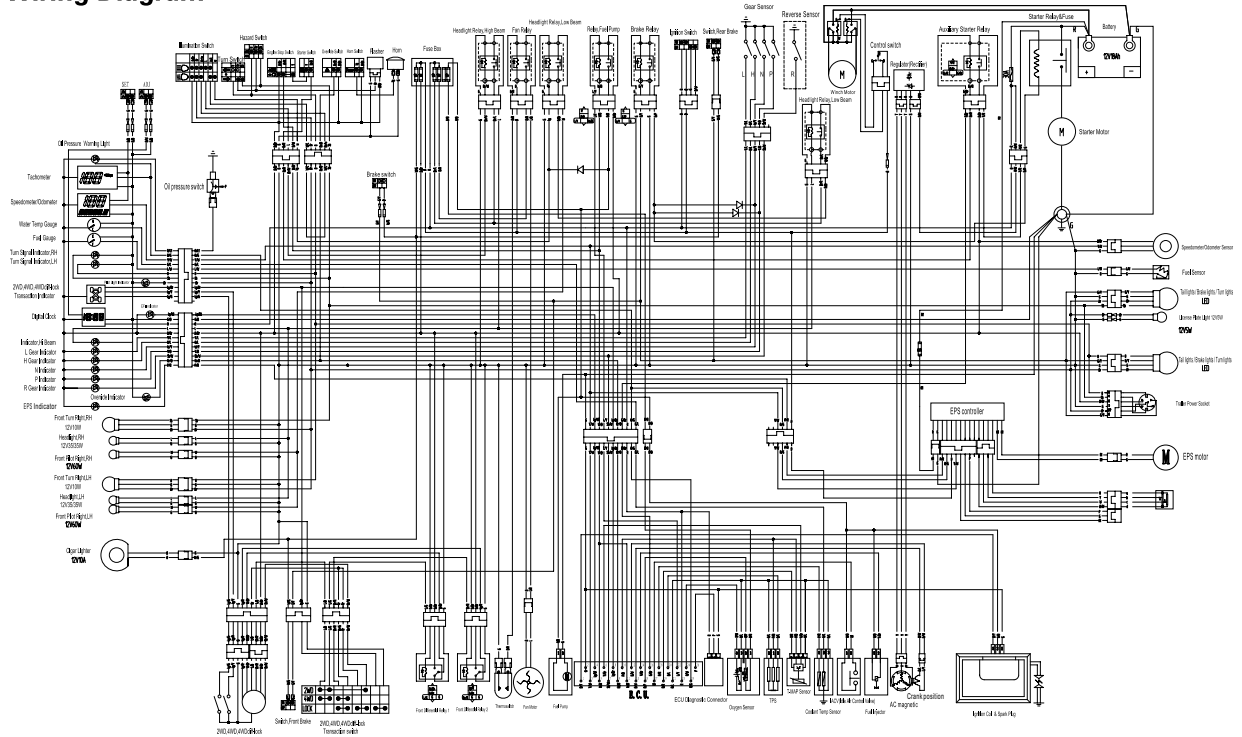

Code	R	SR	B	BR	BT	BL	BR	G	GR	GY	GB	GW	GL	L	LR	LB	LG	O	OR	OW	OL	W	WT	WL	WB	WC	WB	WGR	WLR
Color	Red	Red/Black	Blue	Blue/Black	Black	Black/Red	Black/Blue	Green	Green/Black	Yellow	Yellow/Black	White	White/Black	Light Blue	Light Blue/Black	Light Green	Light Green/Black	Orange	Orange/Black	Brown	Brown/Black	Black	Black/White	Black/Red	Black/Blue	Black/White	Black/Black	Black/White	Black/Black
Wire	Y	YR	YB	YBL	Y	BR	BL	G	GR	GY	GB	GW	GL	L	LR	LB	LG	O	OR	OW	OL	W	WT	WL	WB	WC	WB	WGR	WLR
Label	W	WR	WB	WBL	W	BR	BL	G	GR	GY	GB	GW	GL	L	LR	LB	LG	O	OR	OW	OL	W	WT	WL	WB	WC	WB	WGR	WLR



ZHEJIANG CFMOTO POWER CO., LTD.

No.116,Wuzhou Road,Yuhang Economic Development Zone,
Hangzhou 311100,Zhejiang Province
Tel: 86-571-89265799 Fax: 86-571-89265788
E-mail: export@cfmoto.com.cn www.cfmoto.cn
Design on July, 2015