

EXPERIENCE  
more  
TOGETHER.

cfmoto.it

IMEX s.r.l.  
importatore ufficiale CFMOTO  
tel. +39.0392496207  
E-mail: info@imex-srl.com

Facebook: cfmotoitalia  
Instagram: cfmoto\_italy  
Youtube: CFMOTO ITALIA



2021

ACCESSORI  
CFMOTO



# CFORCE

## 450 S/L & 520 S/L



### Front Bumper Assembly

Accessory Code: 9GQ0-200300

**Features:**

- Steel Tube Diameter:  $\Phi$ 35mm
- Wall Thickness: 2mm
- Easy To Install
- Front Vehicle Protection
- Headlight Full Protection
- E-coated With Black Powder Coat



Prezzo: 195,00 Euro + i.v.a

### Rear Bumper Assembly

Accessory Code: 9GQ0-200400

**Features:**

- Steel Tube Diameter:  $\Phi$ 35mm
- Wall Thickness: 2mm
- Easy To Install
- Rear Vehicle Protection
- Taillight Protection
- E-coated With Black Powder Coat



Prezzo: 195,00 Euro + i.v.a

### Nerf Bars Assembly-1up

Accessory Code: 9GQ0-200500

**Features:**

- Steel Tube Diameter:  $\Phi$ 35mm
- Wall Thickness: 2mm
- Easy To Install
- E-coated With Black Powder Coat
- Durable And Solid



Prezzo: 245,00 Euro + i.v.a

### Nerf Bars Assembly-2up

Accessory Code: 9GQL-200500

**Features:**

- Steel Tube Diameter:  $\Phi$ 35mm
- Wall Thickness: 2mm
- Easy To Install
- E-coated With Black Powder Coat
- Durable And Solid



Prezzo: 255,00 Euro + i.v.a

### Front Rack Extender Assembly

Accessory Code: 9CR6-200600

**Features:**

- Integrated Rack Extender
- Steel Tube Diameter:  $\Phi$ 22mm
- Easy To Install
- E-coated With Black Powder Coat
- Durable And Solid
- Helps Keep Cargo Securely In Place



Prezzo: 129,50 Euro + i.v.a

### Rear Rack Extender Assembly

Accessory Code: 9CR6-200700

**Features:**

- Integrated Rack Extender
- Steel Tube Diameter:  $\Phi$ 22mm
- Easy To Install
- E-coated With Black Powder Coat
- Durable And Solid
- Helps Keep Cargo Securely In Place



Prezzo: 129,50 Euro + i.v.a

### Aluminum Skid Plate Assembly - 1up

Accessory Code: 9GQ0-203000

**Features:**

- Made Of High Strength Aluminum (Thickness 3mm)
- Ultimate Durability
- High Impact Strength
- Offering Great Protection In Rough Terrain

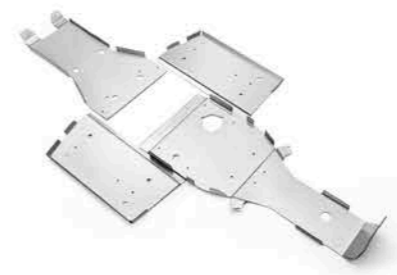

Prezzo: 350,00 Euro + i.v.a

### Aluminum Skid Plate Assembly - 2up

Accessory Code: 9GQL-203000

**Features:**

- Made Of High Strength Aluminum (Thickness 3mm)
- Ultimate Durability
- High Impact Strength
- Offering Great Protection In Rough Terrain



Prezzo: 385,00 Euro + i.v.a



## CFORCE 450 S/L & 520 S/L

### Hand Guard Kit

Accessory Code: 9AW#-804700-2000

**Features:**

- Protect Driver's Hands
- Hard Plastic Cover And Plastic Bracket
- Fit On Cforce 400/500 S/I Perfectly

Prezzo: 75,00 Euro + i.v.a



### Aluminum Winch Armor Assembly

Accessory Code: 9GQ0-200600

**Features:**

- Made Of High Strength Aluminum (Thickness 3mm)
- Ultimate Durability
- High Impact Strength
- Easy To Install



Prezzo: 55,00 Euro + i.v.a

### A-arm Protector Assembly

Accessory Code: 9GQ0-204000

**Features:**

- Made Of High Strength Aluminum (Thickness 3mm)
- Ultimate Durability
- High Impact Strength
- Easy To Install



Prezzo: 145,00 Euro + i.v.a

# CFORCE 625/625 TOURING

### Front Bumper Assembly

Accessory Code: 9DS#-801100-6000

**Features:**

- Steel Tube Diameter:  $\Phi$ 38mm
- Wall Thickness: 2mm
- Easy To Install
- Front Vehicle Protection
- Headlight Protection
- E-coated With Black Powder Coat

Prezzo: 185,00 Euro + i.v.a



### Front Bumper Assembly -Light Protection

Accessory Code: 9DS#-801400-6000

**Features:**

- Steel Tube Diameter:  $\Phi$ 32mm
- Wall Thickness: 2mm
- Easy To Install
- Front Vehicle Protection
- Headlight Full Protection
- E-coated With Black Powder Coat

Prezzo: 195,00 Euro + i.v.a



### Rear Bumper Assembly

Accessory Code: 9DS#-801200-6000

**Features:**

- Steel Tube Diameter:  $\Phi$ 38mm
- Wall Thickness: 2mm
- Easy To Install
- Rear Vehicle Protection
- Taillight Protection
- E-coated With Black Powder Coat

Prezzo: 185,00 Euro + i.v.a

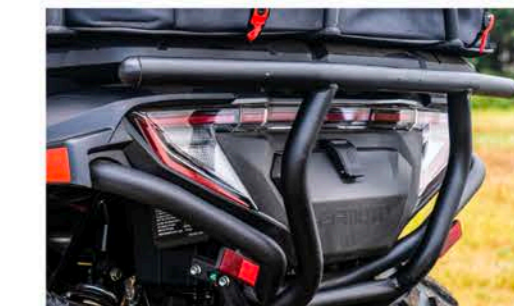

### Rear Bumper Assembly -Light Protection

Accessory Code: 9DS#-801300-6000

**Features:**

- Steel Tube Diameter:  $\Phi$ 32mm
- Wall Thickness: 2mm
- Easy To Install
- Rear Vehicle Protection
- Taillight Full Protection
- E-coated With Black Powder Coat

Prezzo: 195,00 Euro + i.v.a



### Front Rack Extender Assembly - Separated

Accessory Code: 9DS#-802100-6000

**Features:**

- Steel Tube Diameter:  $\varnothing$ 22mm
- Easy To Install
- E-coated With Black Powder Coat
- Durable And Solid
- Helps Keep Cargo Securely In Place

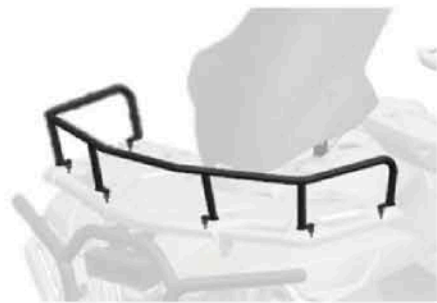

Prezzo: 95,00 Euro + i.v.a

### Rear Rack Extender Assembly - Separated

Accessory Code: 9DS#-802200-6000

**Features:**

- Steel Tube Diameter:  $\varnothing$ 22mm
- Easy To Install
- E-coated With Black Powder Coat
- Durable And Solid
- Helps Keep Cargo Securely In Place

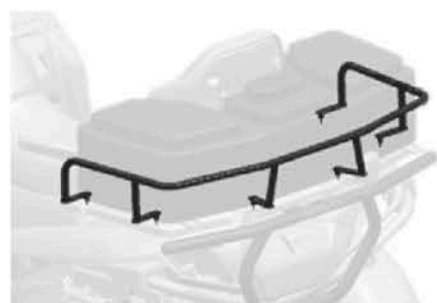

Prezzo: 95,00 Euro + i.v.a



### Windshield Assembly

Accessory Code: 9DS#-805000-6000

**Features:**

- Made Of Impact-resistant Acrylic
- Stable, Quiet At Low/speed Riding Condition
- Strong Resistance Against The Sun-yellowing Effect.
- Driver Wind Protection
- Excellent Visibility
- Easy To Install



Prezzo: 225,00 Euro + i.v.a

### Aluminum Skid Plate Assembly - 2up

Accessory Code: 9CS#-804200-6400

**Features:**

- Made Of High Strength Aluminum (Thickness 5mm)
- Ultimate Durability
- High Impact Strength
- Offering Great Protection In Rough Terrain

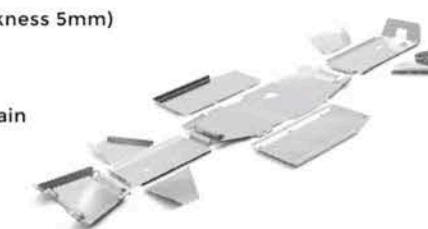

Prezzo: 565,00 Euro + i.v.a

### Aluminum Skid Plate Assembly - 1up

Accessory Code: 9DS#-804300-6000

**Features:**

- Made Of High Strength Aluminum (Thickness 5mm)
- Ultimate Durability
- High Impact Strength
- Offering Great Protection In Rough Terrain

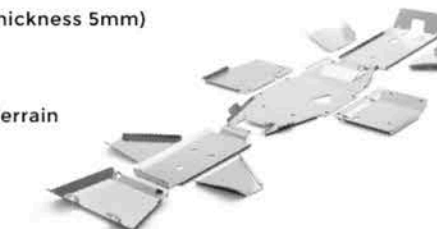

Prezzo: 545,00 Euro + i.v.a

### Cargo Box Assembly

Accessory Code: 9DS#-806100-6000

**Features:**

- Large Storage Capacity (24 Gallons, 90 Liters)
- Lockable Lid
- Water Tight Seal
- With CF Connect, Easy To Install, Tool-less
- Stylish Look
- Heavy Duty Plastic
- No Mounting Holes Inside Of The Cargo Box.



Prezzo: 345,00 Euro + i.v.a

### Canvas Storage Bag

Accessory Code: 9DS#-809200-6000

**Features:**

- Transport Gear In A Weatherproof Bag
- IPX4 Waterproof
- Large Storage Capacity(26 Gallons,99 Liters)
- Designed To Maximize Potential Storage
- Extra Compartments On Top To Store Goods
- \*\*It Can Be Used On CFMOTO CFORCE 625 & 625 Touring, CFORCE 850 XC And CFORCE 1000 with Rear Rack Extender.



Prezzo: 275,00 Euro + i.v.a

# ACCESSORI

# ATV

## Front Bumper Assembly – Overland

Accessory Code: 9AW#-801100-2000

### Features:

- Steel Tube Diameter:  $\Phi$ 38mm
- Wall Thickness: 2mm
- Easy To Install
- Front Vehicle Protection
- Headlight Protection
- Anti-corrosion Coating With Durable Coat Finish



Prezzo: 195,00 Euro + i.v.a

## Rear Bumper Assembly – Overland

Accessory Code: 9AW#-801200-2000

### Features:

- Steel Tube Diameter:  $\Phi$ 38mm
- Wall Thickness: 2mm
- Easy To Install
- Rear Vehicle Protection
- Taillight Protection
- Anti-corrosion Coating With Durable Coat Finish

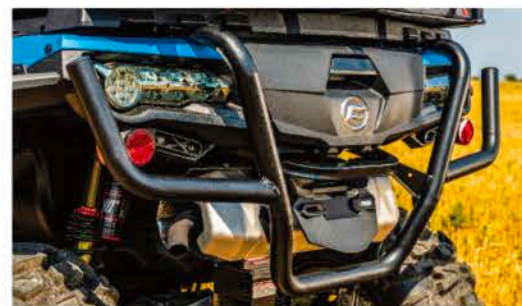

Prezzo: 195,00 Euro + i.v.a

## Nerf Bars Assembly

Accessory Code: 9AWA-800300

### Features:

- Steel Tube Diameter:  $\Phi$ 30mm
- Wall Thickness: 2mm
- E-coated With Black Powder Coat
- Durable And Solid
- \*\*nerf Bars Requires Front And Rear Bumper Assembly To Work.



Prezzo: 265,00 Euro + i.v.a

## Front Bumper Assembly – Light Protection

Accessory Code: 9AWA-800100

### Features:

- Steel Tube Diameter:  $\Phi$ 35mm
- Wall Thickness: 2mm
- Front Vehicle Protection
- Headlight Protection
- E-coated With Black Powder Coat



Prezzo: 195,00 Euro + i.v.a



## Rear Bumper Assembly – Light Protection

Accessory Code: 9AWA-800200

### Features:

- Steel Tube Diameter:  $\Phi$ 35mm
- Wall Thickness: 2mm
- Rear Vehicle Protection
- Taillight Protection
- E-coated With Black Powder Coat
- \*\*this Rear Bumper Assembly Is Not Available For U.S.2021MY CFORCE 850 XC And CFORCE 1000



Prezzo: 195,00 Euro + i.v.a

## Rear Rack Extender Assembly

Accessory Code: 9AW#-802400-2000

### Features:

- Steel Tube Diameter:  $\Phi$ 22mm
- Easy To Install
- E-coated With Black Powder Coat
- Durable And Solid
- Helps Keep Cargo Securely In Place



Prezzo: 125,00 Euro + i.v.a

## Front Rack Extender Assembly

Accessory Code: 9AW#-802300-2000

### Features:

- Steel Tube Diameter:  $\Phi$ 22mm
- Easy To Install
- E-coated With Black Powder Coat
- Durable And Solid
- Helps Keep Cargo Securely In Place



Prezzo: 125,00 Euro + i.v.a

## Windshield Assembly

Accessory Code: 9AW#-806000-2100

### Features:

- Made Of Impact-resistant Acrylic
- Stable, Quiet At Low/speed Riding Condition
- Uv And Weather Endurance With No Yellowing
- Driver Wind Protection
- Excellent Visibility
- Easy To Install



Prezzo: 245,00 Euro + i.v.a

## Hand Guard Assembly With Fairing

Accessory Code: 9AYV-805100-2A00

### Features:

- Integrated Hand Guard Protect Driver's Hands
- Hard Plastic Cover With A Small Fairing
- Fit On CFORCE 850 XC & CFORCE 1000 Perfectly

## Aluminum Winch Armor Assembly

Accessory Code: 9AWA-800400

### Features:

- Made Of High Strength Aluminum (Thickness 3mm)
- Ultimate Durability
- High Impact Strength

Prezzo: 65,00 Euro + i.v.a



## Aluminum Skid Plate Assembly

Accessory Code: 9AWA-800500

### Features:

- Made Of High Strength Aluminum (Thickness 3mm)
- Ultimate Durability
- High Impact Strength
- Offering Great Protection In Rough Terrain

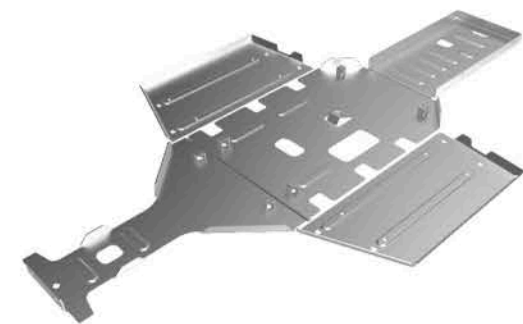

Prezzo: 395,00 Euro + i.v.a

## A-arm Protector Assembly

Accessory Code: 9AWA-800600

### Features:

- Made Of High Strength Aluminum (Thickness 3mm)
- Ultimate Durability
- High Impact Strength
- \*\*for CFORCE 850 XC & CFORCE 1000, not For CFORCE 1000 Overland.



Prezzo: 145,00 Euro + i.v.a

## HDPE Skid Plate Assembly

Accessory Code: 9AWV-804100-2000

### Features:

- Made Of High Density Polyethylene Hdpe (Thickness 8mm)
- Ultimate Durability
- High Impact Strength
- Offering Great Protection In Rough Terrain
- Fit On CFORCE 850 XC & CFORCE 1000 Perfectly

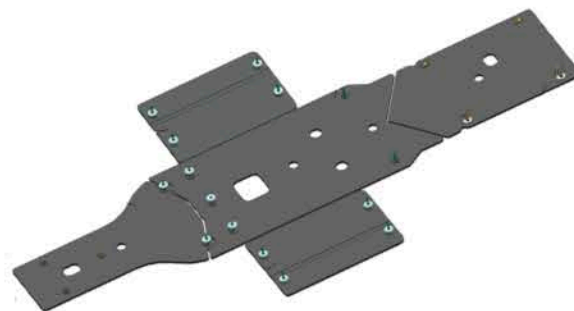

Prezzo: 425,00 Euro + i.v.a

## A-arm Protector Assembly

Accessory Code: 9AWV-804200-2000

### Features:

- Made Of High Strength Aluminum (Thickness 5mm)
- Painting Black
- Ultimate Durability
- High Impact Strength
- \*\*for CFORCE 850 XC & CFORCE 1000, And CFORCE 1000 Overland.



Prezzo: 165,00 Euro + i.v.a

## Rear Cargo Box Assembly

Accessory Code: 9AYV-806100-2A00

### Features:

- Large Storage Capacity (30 Gallons, 115 Liters)
- Lockable Lid
- Water Tight Seal
- With CF Connect, Easy To Install, Tool-less
- Stylish Look
- Heavy Duty Plastic
- Fit On CFORCE 850 XC & CFORCE 1000 Perfectly



Prezzo: 395,00 Euro + i.v.a

## Canvas Storage Bag

Accessory Code: 9DS#-809200-6000

### Features:

- Transport Gear In A Weatherproof Bag
- IPX4 Waterproof
- Large Capacity 99L
- Designed To Maximize Potential Storage
- Extra Compartments On Top To Store Goods
- \*\*it Can Be Used On Cfmoto CFORCE 600, CFORCE 850 XC & CFORCE 1000 With Rack Extender.



Prezzo: 275,00 Euro + i.v.a



Prezzo: 285,00 Euro + i.v.a

## Center Cargo Box Assembly

Accessory Code: 9AYV-806200-2A00

### Features:

- Large Storage Capacity (15.8 Gallons, 60 Liters)
- Lockable Lid
- Water Tight Seal
- With CF Connect, Easy To Install, Tool-less
- Stylish Look
- Heavy Duty Plastic
- Fit On CFORCE 850 XC & CFORCE 1000 Perfectly
- No Mounting Holes Inside Of Cargo Box.



## Vehicle Cover

Accessory Code: 85204Z-00600



### Features:

- This Cover Can Be Used On Cforce For Trailer Traveling.
- This Cover Can Be Enlarged To Cover Cforce Which Equipped Cf Accessories Including Cargo Boxes, Windshield, Front & Rear Bumpers And So On.



Prezzo: 90,00 Euro + i.v.a



## Front Bumper And Rack Assembly

Accessory Code: 7030-801000

### Features:

- Main Steel Tube Diameter:  $\phi$  32mm
- Wall Thickness: 2mm
- Front Vehicle Protection
- Headlight Full Protection
- Front Hood Protection
- Integrated Rack Extension
- E-coated With Black Powder Coat



Prezzo: 375,00 Euro + i.v.a

## Aluminum Skid Plate Assembly

Accessory Code: 7030-800100

### Features:

- Made Of High Strength Aluminum (Thickness 3mm)
- Ultimate Durability
- High Impact Strength
- Offering Great Protection In Rough Terrain



Prezzo: 475,00 Euro + i.v.a

## A-arm Protector Assembly

Accessory Code: 7030-800200

### Features:

- Made Of High Strength Aluminum (Thickness 3mm)
- Ultimate Durability
- High Impact Strength
- Easy To Install



Prezzo: 235,00 Euro + i.v.a



## UFORCE 550 & 800



### Roof Rack Assembly

Accessory Code: 703A-800400

**Features:**

- Roof Rack Assembly Works On UFORCE 550 & 800
- Increase The Cargo Capacity
- E-coated With Black Powder Coat



Prezzo: 215,00 Euro + i.v.a

### Snorkel Assembly

Accessory Code: 703A-800500

**Features:**

- Perfect Protection Against Dirt And Snow
- Stable, Quiet At Low/speed Riding Condition
- Make UFORCE 550 & 800 Work Well Under Harsh Environment



Prezzo: 225,00 Euro + i.v.a

# UFORCE 1000



### Front Bumper Assembly

Accessory Code: 5HY#-801100-1000

**Features:**

- Steel Tube Diameter 38mm
- Steel Tube Wall Thickness 2mm
- E-coated With Black Powder Coat
- Easy To Install
- Front Vehicle Protection
- Headlight Protection
- Works With Winch And Plow System



Prezzo: 325,00 Euro + i.v.a

### Nerf Bars Assembly

Accessory Code: 5HY#-801300-1000

**Features:**

- Steel Tube Diameter 50mm
- Steel Tube Wall Thickness 2mm
- E-coated With Black Powder Coat
- Easy To Install
- Side Vehicle Protection
- Side Step Capability

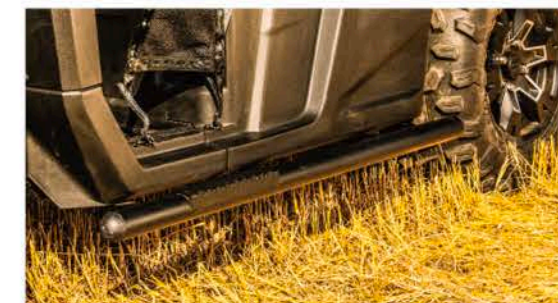

Prezzo: 285,00 Euro + i.v.a

### Rear Bumper Assembly

Accessory Code: 5HY#-801200-1000

**Features:**

- Steel Tube Diameter 38mm
- Steel Tube Wall Thickness 2mm
- E-coated With Black Powder Coat
- Easy To Install
- Rear Vehicle Protection
- Works With Hitch System



Prezzo: 265,00 Euro + i.v.a

### Front Bumper And Rack

Accessory Code: 5HY0-801000

**Features:**

- Integrated Rack Extension
- Made Of  $\Phi$  32mm Steel Pipe
- Front Vehicle Protection
- Headlight Protection
- Anti-corrosion Coating With Durable Coat Finish
- Tough And Strong



Prezzo: 395,00 Euro + i.v.a





**UFORCE 1000**

### Nerf Bars And Rear Bumper Assembly

Accessory Code: 5HY0-802000

**Features:**

- Made Of  $\Phi$  32mm Steel Pipe
- Rear And Side Vehicle Protection
- Taillight Protection
- Anti-corrosion Coating With Durable Coat Finish
- Tough And Strong
- \*\*nerf Bars Can Only Be Installed Together With Front Bumper.



Prezzo: 365,00 Euro + i.v.a

### Snorkel Assembly

Accessory Code: 5HY#-803000-1200

**Features:**

- Perfect Protection Against Dirt And Snow
- Stable, Quiet At Low/speed Riding Condition
- Make UFORCE 1000 Work Well Under Harsh Environment



Prezzo: 265,00 Euro + i.v.a

### Cage Assembly

Accessory Code: 5HY0-803000

**Features:**

- Extend The Capacity Of Dumping Box
- Tough And Strong
- Anti-corrosion Coating With Durable Coat Finish
- This Cage Need 12 Units Quick Release Clamps (5HY0-809100) To Install



Prezzo: 595,00 Euro + i.v.a

### Windshield Assembly / Wiper Assembly

Accessory Code: 5HY#-805100-1200 / 5HY0-806130

**Features:**

- Stable, Quiet At Low/speed Riding Condition
- UV And Weather Endurance With No Sun Yellowing
- Driver Wind Protection
- Excellent Visibility, Even In Raining
- Easy To Install



Prezzo parabrezza front: 495,00 Euro + i.v.a  
Prezzo tergicristallo: 175,00 Euro + i.v.a

### Rear Panel Assembly

Accessory Code: 5HY#-805200-1200-10

**Features:**

- Stable, Quiet At Low/speed Riding Condition
- UV And Weather Endurance With No Sun Yellowing
- Driver Wind Protection
- Excellent Visibility
- Easy To Install



Prezzo: 325,00 Euro + i.v.a

### Center Mirror Assembly

Accessory Code: 5HY#-805600-1200

**Features:**

- Perfect Fit On UFORCE 1000
- Wide Range Rear View
- Stable, Quiet At Low/speed Riding Condition
- \*\*it Can Be Installed On UFORCE 600, UFORCE 1000



Prezzo: 35,00 Euro + i.v.a

### Center Mirror Assembly Premium

Accessory Code: 5BWV-805600-5000

**Key Features:**

- Large Range Rear Review
- Aluminum Mounting Brackets
- Easy To Install
- \*\*available For UFORCE 600, UFORCE 1000, ZOFRC 950/1000 SPORT



Prezzo: 85,00 Euro + i.v.a



## Side Mirrors Assembly

Accessory Code: 5HY#-805500-1200

### Features:

- Perfect Fit On UFORCE 1000
- Wide Range Rear View
- Make UFORCE 1000 Ride More Safe
- Stable, Quiet At Low/speed Riding Condition
- \*\*it Can Be Installed On UFORCE 600, UFORCE 1000



Prezzo: 125,00 Euro + i.v.a

## A-arm Protector Assembly

Accessory Code: 5HY0-805100

### Features:

- Made Of High Strength Aluminum (Thickness 3mm)
- Ultimate Durability
- High Impact Strength
- Offering Great Protection In Rough Terrain



Prezzo: 145,00 Euro + i.v.a

## Skid Plate Assembly

Accessory Code: 5HY0-805200

### Features:

- Made Of High Strength Aluminum (Thickness 3mm)
- Ultimate Durability
- High Impact Strength
- Offering Great Protection In Rough Terrain



Prezzo: 745,00 Euro + i.v.a

UFORCE 1000

UFORCE 1000 SPORT

## Front Bumper Assembly With Brush Guard

Accessory Code: 5BY#-801100-1000

### Features:

- Steel Tube Diameter:  $\Phi$ 38mm
- Wall Thickness: 2mm
- Easy To Install
- Front Vehicle Protection
- Headlight Protection
- E-coated With Black Powder Coat



Prezzo: 325,00 Euro + i.v.a

## Rear Bumper Assembly

Accessory Code: 5BY#-801200-1000

### Features:

- Steel Tube Diameter:  $\Phi$ 38mm
- Wall Thickness: 2mm
- Easy To Install
- Rear Vehicle Protection
- Taillight Protection
- E-coated With Black Powder Coat



Prezzo: 295,00 Euro + i.v.a

## Nerf Bars Assembly

Accessory Code: 5BY#-801300-1000

### Features:

- Steel Tube Diameter:  $\Phi$ 38mm
- Wall Thickness: 2mm
- Easy To Install
- Side Vehicle Protection
- E-coated With Black Powder Coat

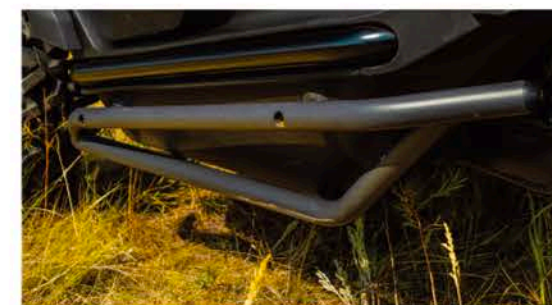

Prezzo: 250,00 Euro + i.v.a

## Headlight Protector Assembly

Accessory Code: 5BYV-801400-1000

### Features:

- Steel Tube Diameter:  $\Phi$ 38mm
- Wall Thickness: 2mm
- Easy To Install
- Headlight Protection
- E-coated With Black Powder Coat
- \*\*available For ZFORCE 1000 SPORT Equipped Front Bumper Assembly (5BY#-801100-1000)



Prezzo: 225,00 Euro + i.v.a

**ZFORCE 1000 SPORT****Center Mirror Assembly**

Accessory Code: 5BWV-805600-5000

**Features:**

- Excellent Rear View Visibility.
- Aluminum Mounting Brackets
- Easy To Install
- \*\*available For UFORCE 600, UFORCE 1000, ZOFRC 950/1000 SPORT



Prezzo: 85,00 Euro + i.v.a

**Front Fender LH, RH**

Accessory Code:

5BY0-043031-10000 (LH)

5BY0-043032-10000 (RH)

**Features:**

- Front fender Polypropylene
- Easy to install
- available For ZFORCE1000 SPORT



Prezzo: 75,00 Euro + i.v.a (LH + RH)

**Rear Cargo Box Assembly**

Accessory Code: 5BYV-806100-1000

**Features:**

- Large Storage Capacity (26 Gallons, ~100 Liters)
- Lockable Lid
- Water Tight Seal
- With CF Connect, Easy To Install, Tool-less
- Stylish Look
- Heavy Duty Plastic
- No Mounting Holes Inside Of Cargo Box



Prezzo: 395,00 Euro + i.v.a

**Side Mirrors Assembly**

Accessory Code: 5BY#-805500-1000

**Features:**

- The Mirror Area Is More Than 300 Cm<sup>2</sup>
- Aluminum Mounting Brackets
- Easy To Install
- Comply To Europe Standard



Prezzo: 195,00 Euro + i.v.a

**Lower Door Inserts Assembly**

Accessory Code: 5BY#-807000-1000

**Features:**

- Injection Molded Polypropylene, Textured
- Reinforce Main Panel
- Easy To Install
- Full Lower Door Coverage
- Good Seal
- Excellent Fit And Finish



Prezzo: 390,00 Euro + i.v.a

**Vehicle Cover**

Accessory Code: UNIS-850300

**Features:**

- Fit On ZFORCE 950 SPORT And ZFORCE 1000 SPORT
- Dust Proof
- Water Proof
- Ultraviolet Proof



Prezzo: 115,00 Euro + i.v.a



### Kit cabina UFORCE 550/800

**Accessory Code:**

64S01U01-0

**Features:**

- Windshield ventilation position possible
- Wiper and washer
- Exterior rear-view mirrors
- Safety glass windshield
- Extremely resistant metal roof panel
- Sound-proof roof insulation
- Polycarbonate door with double-layer hardened coating (both sides)
- Sliding door window

Prezzo: 3750,00 Euro + i.v.a



### Kit cabina ZFORCE 550/800/1000

**Accessory Code:**

64S02U01-0

**Features:**

- Windshield ventilation position possible
- Wiper and washer
- Exterior rear-view mirrors
- Safety glass windshield
- Extremely resistant metal roof panel
- Sound-proof roof insulation
- Polycarbonate door with double-layer hardened coating (both sides)
- Sliding door window

Prezzo: 3750,00 Euro + i.v.a



### Kit cabina UFORCE1000

**Accessory Code:**

64S03U01-0

**Features:**

- Windshield ventilation position possible
- Wiper and washer
- Exterior rear-view mirrors
- Safety glass windshield
- Extremely resistant metal roof panel
- Sound-proof roof insulation
- Polycarbonate door with double-layer hardened coating (both sides)
- Sliding door window
- Without top roof

Prezzo: 3850,00 Euro + i.v.a



### Kit cabina ZFORCE1000 SPORT

**Accessory Code:**

64S07U01-0

**Features:**

- Windshield ventilation position possible
- Wiper and washer
- Exterior rear-view mirrors
- Safety glass windshield
- Extremely resistant metal roof panel
- Sound-proof roof insulation
- Polycarbonate door with double-layer hardened coating (both sides)
- Sliding door window

Prezzo: 3950,00 Euro + i.v.a

